

# 3169-20

# HIOKI

# 3169-21

## Instruction Manual

# CLAMP ON POWER HiTESTER



# EN

Jan. 2019 Revised edition 11  
3169A981-11 19-01H





# Contents

Introduction .....	1
Standard Accessories and Options .....	1
Safety Notes .....	4
Usage Notes .....	7

## **1 Overview 13**

---

1.1 Product Overview .....	13
1.2 Features .....	14

## **2 Parts Names 17**

---

2.1 Instrument Labels and Functions .....	18
2.2 Screen Names and Display Elements .....	22
2.2.1 Screen Configuration .....	22
2.2.2 Common Display .....	23
2.2.3 On-Screen Indicators .....	24

## **3 Measurement Preparations 25**

---

3.1 Banding the L9438-53 Voltage Cord .....	25
3.2 Pre-Operation Inspection .....	26
3.3 Connection Procedure .....	27
3.4 Connecting the Power Cord .....	28
3.5 Connecting the Voltage Cords .....	29
3.6 Using a Clamp-On Sensor (Option) .....	32
3.6.1 Clamp-On Sensor Specifications .....	32
3.6.2 Connecting a Clamp-on Sensor .....	34
3.7 Turning the Power On/Off .....	36

## **4 Connecting to Lines to be Measured 37**

---

4.1 Connection Procedure .....	37
--------------------------------	----

4.2	Connection Methods .....	38
4.2.1	Displaying the Wiring Diagram .....	38
4.2.2	Basic Wiring for Single-Circuit Measurement ....	41
4.2.3	Wiring for Multiple-Circuit Measurement .....	47
4.2.4	Connection to a Line to Be Measured .....	50
4.2.5	Checking the Wiring .....	52
4.3	Measurement Range .....	56

## **5 Setting Procedure 59**

---

5.1	Setting Screen .....	59
5.2	Setting on the Measurement Setting Screen (MEASUREMENT) .....	60
5.2.1	Setting the Wiring Method .....	61
5.2.2	Setting the Synchronization Method .....	63
5.2.3	Setting the Reactive-Power-Meter Method .....	64
5.2.4	Setting the Display Average Times .....	66
5.2.5	Setting the Voltage Range .....	67
5.2.6	Setting the VT Ratio (PT Ratio) .....	68
5.2.7	Setting the Current Range .....	69
5.2.8	Setting the CT Ratio .....	70
5.2.9	Setting the Clamp-On Sensor .....	71
5.3	Setting on the Data Output Setting Screen (DATA OUTPUT) .....	72
5.3.1	Setting the Time-Series Measurement Start Method .....	73
5.3.2	Setting Time-Series Measurement Stop Method	75
5.3.3	Setting Interval .....	78
5.3.4	Setting Medium for Saving Data .....	79
5.3.5	Setting the Data File Name .....	80
5.3.6	Setting Device to Be Connected to the RS-232C	81
5.3.7	Setting the Medium to which the Screen is to be Copied .....	82
5.4	Setting on the Save/Print Items Setting Screen (SAVE, PRINT ITEMS) .....	83

5.4.1	Checking the number of output data items and Storable Time .....	83
5.4.2	Setting Normal Measurement-Data Output Items .....	84
5.4.3	Setting Integrated power and Demand Measurement-data Output Items .....	85
5.4.4	Setting Harmonic Measurement-data Output Items .....	86
5.5	Setting on the System Setting Screen .....	89
5.5.1	Setting the THD Calculation Method .....	90
5.5.2	Setting the Harmonic Order for Display .....	91
5.5.3	Setting the RS-232C .....	92
5.5.4	Setting the LCD Backlight .....	93
5.5.5	Setting the Beep Sound .....	94
5.5.6	Setting the ID No. ....	95
5.5.7	Setting the Clock .....	96
5.5.8	Setting the Language .....	97
5.5.9	Displaying the Serial No. and Version .....	98

## **6 Measurement Method 99**

---

6.1	Measuring the Voltage, Current, and Power (Instantaneous Values) .....	99
6.2	Measuring the Power of Each Phase (Instantaneous values) .....	101
6.3	Displaying a Waveform .....	102
6.4	Measuring the Average, Maximum, and Minimum Values .....	104
6.4.1	Displaying the Voltage, Current, and Power (Average, Maximum, and Minimum Values) ....	105
6.4.2	Displaying the Average, Maximum, and Minimum Power Measurements of Each Phase .....	106
6.5	Measuring Integrated power .....	107
6.6	Performing Demand Measurement .....	108
6.7	Measuring Harmonic .....	109
6.7.1	Displaying a Harmonic List .....	109
6.7.2	Displaying a Harmonic Graph .....	112

1

2

3

4

5

6

7

8

9

10

11

12

13

14



9.1 RS-232C Connection ..... 150  
 9.2 Setting the RS-232C ..... 152

**10 Using the External Input/Output Terminal 155**

---

10.1 Connecting the External Input/Output Terminal ..... 155  
 10.2 Functions of the External Input/Output Terminal ..... 156  
 10.3 Controlling Multiple Units of the 3169-20/21 .. 159

**11 Using D/A Output (3169-21 only) 161**

---

11.1 Connecting the D/A Output Terminal ..... 161  
 11.2 Setting D/A Output ..... 163  
     11.2.1 Setting D/A Output Items ..... 163  
     11.2.2 Setting the Integrated Power Output Rate ..... 165  
 11.3 Response of Output ..... 166  
 11.4 Output Waveform ..... 168

**12 Operations in the Event of Power Outage 173**

---

**13 Specifications 175**

---

13.1 General Specification ..... 175  
 13.2 Formulae ..... 184  
 13.3 Range Configuration and Accuracy by Clamp-On  
     -Sensor ..... 188

**14 Maintenance and Service 193**

---

14.1 Cleaning and Storage ..... 193  
 14.2 Repair and Servicing ..... 194  
 14.3 Error Messages ..... 196

1

2

3

4

5

6

7

8

9

10

11

12

13

14

14.4 System Reset ..... 199  
14.5 Instrument Disposal ..... 200

**Appendix** **203**

---

Power Measurement by the 2 Power-Meter Method and  
U3/I3 Measurement Theory (3P3W2M mode) ..... 203  
Headers of Output Data ..... 205  
Harmonic Phase Angles ..... 209  
Output Data ..... 211

**Index** **i**

---





# Introduction

Thank you for purchasing the HIOKI 3169-20/21 CLAMP ON POWER HiTESTER. To obtain maximum performance from the product, please read this manual first, and keep it handy for future reference.

- Refer to the Quick Start Manual provided with this device.
- For current input with this device, a clamp-on sensor (optional) is required. For details, refer to the instruction manual for the clamp-on sensor you are using.

## Standard Accessories and Options

### Checking the contents of the package

When you receive the product, inspect it carefully to ensure that no damage occurred during shipping. In particular, check the accessories, panel switches, and connectors. If damage is evident, or if it fails to operate according to the specifications, contact your dealer or Hioki representative.

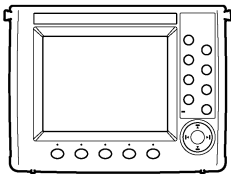

3169-20/21  
CLAMP ON POWER  
HiTESTER



Quick Start  
Manual



Instruction  
Manual



- RS-232C Instruction Manual
- CSV Conversion Software (CD-R)

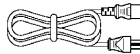

Power Cord



Input Cord Label

- ❖ Refer to 3.6.2 "Connecting a Clamp-on Sensor" (page 34)

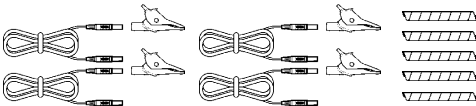

L9438-53 Voltage Cord 1 set (4 cords)

Alligator Clip 4 clips  
( red, yellow, blue, and black /1 each)

Test Leads 4 cords  
( red, yellow, blue, and black /1 each)

Spiral Tube 5 pieces

(for banding the cords)

- ❖ Refer to 3.1 "Banding the L9438-53 Voltage Cord" (page 25)

9441 CONNECTION CABLE  
(for D/A output, 3169-21 only)

- ❖ Refer to 11 "Using D/A Output (3169-21 only)" (page 161)



## Options

### Clamps Voltage output type:

- 9660 CLAMP ON SENSOR (100 A rms rating)
- 9661 CLAMP ON SENSOR (500 A rms rating)
- 9667 FLEXIBLE CLAMP ON SENSOR (5000 A rms rating)
- CT9667 FLEXIBLE CLAMP ON SENSOR (5000 A rms rating)
- 9669 CLAMP ON SENSOR (1000 A rms rating)
- 9694 CLAMP ON SENSOR (5 Arms rating)
- 9695-02 CLAMP ON SENSOR (50 Arms rating)
- 9695-03 CLAMP ON SENSOR (100 Arms rating)
- 9219 CONNECTION CABLE (for 9695-02/03)
- 9290-10 CLAMP ON ADAPTER  
(continuous 1000 A, up to 1500 A, CT ratio 10:1)

- ### Interface
- 9440 CONNECTION CABLE (for external input/output terminal)
  - 9441 CONNECTION CABLE (for D/A output, 3169-21 only)
  - 9612 RS-232C CABLE (for PC)

- ### Printers
- 9442 PRINTER (with 1 roll of thermally sensitized paper supplied, with battery pack)
  - 9443-01 AC ADAPTER (for printers) for Japan
  - 9443-02 AC ADAPTER (for printers) for EU
  - 1196 RECORDING PAPER (25 m, 10 rolls)

- ### Transport case
- 9720-01 CARRYING CASE (The voltage cords and clamp-on sensor are also housed in the case.)  
(9720 CARRYING CASE)

- ### Other peripherals
- 9626 PC Card 32 MB (32 MB compact Flash card + adapter)
  - 9627 PC Card 64 MB (64 MB compact Flash card + adapter)
  - 9726 PC Card 128 MB (128 MB compact Flash card + adapter)
  - 9727 PC Card 256 MB (256 MB compact Flash card + adapter)
  - 9728 PC Card 512 MB (512 MB compact Flash card + adapter)
  - 9804-01 Magnet Adapter (one red, for changing the voltage cord tips, the diameter of the tip is  $\phi 11$  mm)
  - 9804-02 Magnet Adapter (one black, for changing the voltage cord tips, the diameter of the tip is  $\phi 11$  mm)

- ### Software
- SF1001 POWER LOGGER VIEWER (PC application software)
  - 9625 POWER MEASUREMENT SUPPORT SOFTWARE  
(PC application software)

## Before using the 3169-20/21

- Before using the product the first time, verify that it operates normally to ensure that no damage occurred during storage or shipping. If you find any damage, contact your dealer or Hioki representative.
- Before using the product, make sure that the insulation on the L9438-53 Voltage Cord is undamaged and that no bare conductors are improperly exposed. Using the product in such conditions could cause an electric shock, so contact your dealer or Hioki representative for repair.

## Shipping precautions

Use the original packing materials when reshipping the product, if possible.

## Safety Notes

---

This manual contains information and warnings essential for safe operation of the product and for maintaining it in safe operating condition. Before using the product, be sure to carefully read the following safety notes.

### DANGER



**This product is designed to comply with IEC 61010 Safety Standards, and has been thoroughly tested for safety prior to shipment. However, mishandling during use could result in injury or death, as well as damage to the product. Using the product in a way not described in this manual may negate the provided safety features.**

**Be certain that you understand the instructions and precautions in the manual before use. We disclaim any responsibility for accidents or injuries not resulting directly from product defects.**

## Safety Symbols

In the manual, the  symbol indicates particularly important information that the user should read before using the product.



The  symbol printed on the product indicates that the user should refer to a corresponding topic in the manual (marked with the  symbol) before using the relevant function.



Indicates AC (Alternating Current).





Indicates the ON side of the power switch.





Indicates the OFF side of the power switch.

The following symbols in this manual indicate the relative importance of cautions and warnings.

 <b>DANGER</b>	Indicates that incorrect operation presents an extreme hazard that could result in serious injury or death to the user.
 <b>WARNING</b>	Indicates that incorrect operation presents a significant hazard that could result in serious injury or death to the user.
 <b>CAUTION</b>	Indicates that incorrect operation presents a possibility of injury to the user or damage to the product.
<b>NOTE</b>	Advisory items related to performance or correct operation of the product.

## Other Symbols

	Indicates the prohibited action.
	Indicates the reference.
	Indicates quick references for operation and remedies for troubleshooting.
*	Indicates terminology explained at the bottom of the page.

## Accuracy

We define measurement tolerances in terms of f.s. (full scale), rdg. (reading) and dgt. (digit) values, with the following meanings:

**f.s.** (maximum display value or scale length)

The maximum displayable value or the full length of the scale.

This is usually the maximum value of the currently selected range.

**rdg.** (reading or displayed value)

The value currently being measured and indicated on the measuring product.

**dgt.** (resolution)

The smallest displayable unit on a digital measuring product, i.e., the input value that causes the digital display to show a "1".

## Measurement categories

This product complies with CAT III safety requirements. To ensure safe operation of measurement product, IEC 61010 establishes safety standards for various electrical environments, categorized as CAT II to CAT IV, and called measurement categories.

- CAT II Primary electrical circuits in equipment connected to an AC electrical outlet by a power cord (portable tools, household appliances, etc.)  
CAT II covers directly measuring electrical outlet receptacles.
- CAT III Primary electrical circuits of heavy equipment (fixed installations) connected directly to the distribution panel, and feeders from the distribution panel to outlets.
- CAT IV The circuit from the service drop to the service entrance, and to the power meter and primary overcurrent protection device (distribution panel).

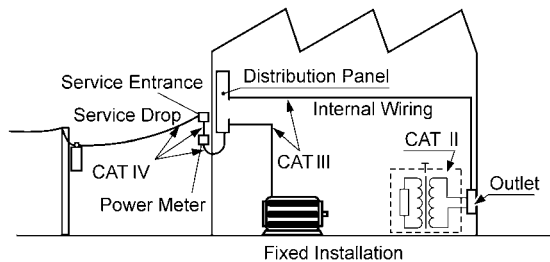

Using a measurement product in an environment designated with a higher-numbered category than that for which the product is rated could result in a severe accident, and must be carefully avoided. Use of a measurement instrument that is not CAT-rated in CAT II to CAT IV measurement applications could result in a severe accident, and must be carefully avoided.

# Usage Notes

---

Follow these precautions to ensure safe operation and to obtain the full benefits of the various functions.

## WARNING



Do not get wet.



Do not touch with bare hands.



Check the voltage.

-  AC 100 V
-  to 240 V

## To avoid electric shock

- Do not allow the product to get wet, and do not use it when your hands are wet.
- When measuring live lines, wear appropriate protective gear, such as insulated rubber gloves, boots and a safety helmet.
- Before turning the product on, make sure the source voltage matches that indicated on the product's power connector. Connection to an improper supply voltage may damage the product and present an electrical hazard.
- To avoid electrical accidents and to maintain the safety specifications of this product, connect the power cord only to a 3-contact (two-conductor + ground) outlet.
- Do not use the product where it may be exposed to corrosive or combustible gases. The product may be damaged or cause an explosion.

## Setting up the 3169-20/21

### CAUTION

Avoid the following:

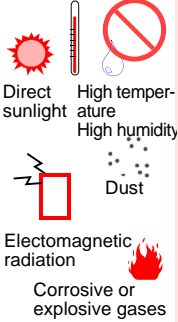

- This product is designed for indoor use, and operates reliably from 0°C to 40°C.
- Do not store or use the product where it could be exposed to direct sunlight, high temperature or humidity, or condensation. Under such conditions, the product may be damaged and insulation may deteriorate so that it no longer meets specifications.
- This product is not designed to be entirely water- or dust-proof. To avoid damage, do not use it in a wet or dusty environment.
- Do not use the product near a device that generates a strong electromagnetic field or electrostatic charge, as these may cause erroneous measurements.

### NOTE

This product may cause interference if used in residential areas. Such use must be avoided unless the user takes special measures to reduce electromagnetic emissions to prevent interference to the reception of radio and television broadcasts.

## Handling this device

### CAUTION

- To avoid damage to the product, protect it from vibration or shock during transport and handling, and be especially careful to avoid dropping.
- Be careful to avoid dropping the clamps or otherwise subjecting them to mechanical shock, which could damage the mating surfaces of the core and adversely affect measurement.



## Using the clamp-on sensors and voltage cords



Connect the clamp-on sensors or voltage cords to the instrument first, and then to the active lines to be measured. Observe the following to avoid electric shock and short circuits.

- To avoid short circuits and potentially life-threatening hazards, never attach the clamp to a circuit that operates at more than the maximum rated voltage to earth (9660: 300 VAC, 9661: 600 VAC, 9667/CT9667: 1000 VAC, 9669: 600 VAC, 9694: 300 VAC, 9695-02/03: 300 VAC), or over bare conductors.
- Clamp sensor and voltage cord should only be connected to the secondary side of a breaker, so the breaker can prevent an accident if a short circuit occurs. Connections should never be made to the primary side of a breaker, because unrestricted current flow could cause a serious accident if a short circuit occurs.
- Do not allow the voltage cord clips to touch two wires at the same time. Never touch the edge of the metal clips.
- Use only the supplied L9438-53 Voltage Cord to connect the product input terminals to the circuit to be tested.
- To prevent an electric shock accident, confirm that the white or red portion (insulation layer) inside the cable of voltage cord is not exposed. If a color inside the cable is exposed, do not use the cable.
- When the clamp sensor is opened, do not allow the metal part of the clamp to touch any exposed metal or to short across two lines, and do not use over bare conductors.
- The current input terminals of the 3169-20/21 are not insulated. To avoid the risk of electric shock, only use the specified optional clamp-on sensor.

## Handling the cords

### CAUTION

- Keep in mind that, in some cases, conductors to be measured may be hot.
- To avoid damaging the power cord, grasp the plug, not the cord, when unplugging the cord from the power outlet.
- To avoid damaging the voltage cords or clamp sensor cables, do not bend or pull near their ends.
- Avoid stepping on or pinching the cable, which could damage the cable insulation.
- Keep the cables well away from heat sources, as bare conductors could be exposed if the insulation melts.
- When disconnecting the BNC connector, be sure to release the lock before pulling off the connector. Forcibly pulling the connector without releasing the lock, or pulling on the cable, can damage the connector.
- Failure to fasten the connectors properly may result in sub-specification performance or damage to the equipment.

## Input

### DANGER

#### **Maximum input voltage and maximum rated voltage to earth**

- The maximum input voltage of the product is 780 Vrms, 1103 V peak. Do not measure the voltage exceeding that. It causes the personal injury as well as damages the product.
- The maximum rated voltage to earth of the product is 600 Vrms. Do not measure the voltage to earth exceeding that. It causes the personal injury as well as damages the product.
- The maximum rated voltage to earth of clamp sensor depends on the type of clamp sensor used.  
To avoid electric shock, refer to the instruction manual of a clamp sensor used.

**⚠ CAUTION**

- To avoid damage to the product, do not short-circuit the output terminal and do not input voltage to the output terminal.
- Voltage input terminals  $U_1$ ,  $U_2$ , and  $U_3$  are common to the N terminal and are not insulated. To avoid the risk of electric shock, do not touch the terminals.
- Note that the product may be damaged if current or voltage exceeding the selected measurement range is applied for a long time
- When the power is turned off, do not apply voltage or current to the voltage input terminals or clamp sensor. Doing so may damage the product.
- To prevent damage to the instrument and sensor, never connect or disconnect a sensor while the power is on, or while the sensor is clamped around a conductor.

**Using VT(PT) and CT****NOTE**

- When the voltage or current for the power line being measured exceeds the maximum input for this device, use an external VT(PT) or CT.
- When using an external VT(PT) or CT, make sure you use a device with a minimal phase difference. By setting the VT(PT) or CT ratio, you can read measurement values directly.

**Measurement values****NOTE**

- To ensure measurements are precise, warm up the device for at least 30 minutes after plugging it in.
- This device is designed to measure commercial power lines with a frequency of 50 or 60 Hz. It cannot measure power lines of other frequencies or power lines where the waveforms are controlled using an inverter.
- This device cannot measure power lines with superposed direct current.
- This device uses algorithms to measure values for input voltage and current waveforms using (see the specifications). On devices using different operation principles or algorithms differ, differences in measurement values may result.
- The voltage and current measurements will be reduced to zero when inputs are less than 0.4% of the measurement range. When the voltage or current is zero, the active power, reactive power, and apparent power measurements will be reduced to zero and the power factor will be treated as invalid data.



# Overview

1

1

1.1 Product Overview

## 1.1 Product Overview

The 3169-20/21 CLAMP ON POWER HiTESTER is a clamp-on wattmeter designed to measure lines ranging from a single-phase line to a three-phase 4-wire line.

The 3169-20/21 can measure demand and harmonics, which are important for power management, as well as such basic measurements of voltage, current, power, power factor, and integrated power (watt-hours).

The 3169-20/21 supports extended data acquisition and automated measurement, thanks to the use of the PC card and RS-232C interface. This makes the 3169-20/21 suitable for power measurement at commercial frequencies involved in the power maintenance and management of a building or factory.

## 1.2 Features

- ◆ **Safe design**  
Designed to comply with safety standard EN61010-1.
- ◆ **Supports a variety of power lines**  
Measures single-phase 2-wire, single-phase 3-wire, three-phase 3-wire and three-phase 4-wire systems.  
Capable of measuring multiple circuits of the same voltage system (same transformer) using one 3169-20/21 unit.
  - Single-phase 2-wire: 4 circuits
  - Single-phase 3-wire: 2 circuits
  - Three-phase 3-wire: 2 circuits
- ◆ **Detection of Incorrect Connection**  
On the wiring check screen, you can check whether the phase sequence is correct, voltage cord is connected, and whether the clamp-on sensor is connected in reverse to avoid incorrect connection.
- ◆ **Simultaneous Display of Various Measurements**  
Measurements of voltage, current, active/reactive/apparent power, power factor, and frequency are displayed simultaneously.
- ◆ **Independent Integration for Different Polarities**  
Capable of integrating different polarities independently, such as active power consumption/regeneration and reactive power lag/lead.
- ◆ **Three-Voltage, Three-Current Measurement**  
Capable of measuring 3-voltage, 3-current when the 3169-20/21 is connected to a three-phase, 3-wire line.
- ◆ **Harmonic Measurement**  
Capable of measuring the harmonics of a power line simultaneously with integrated power (watt-hour) measurement.
- ◆ **Maximum, Minimum, and Average Measurement**  
Capable of measuring the maximum, minimum, and average values of the voltage, current, and power calculated for each waveform (per interval.)
- ◆ **PC Card Interface**  
Saves measurement data on a PC card for an extended period. The settings can be saved or read out using the PC card.

◆ **RS-232C Interface**

The 3169-20/21 includes an RS-232C interface as standard equipment. The instrument is connected to a PC by the interface, and is used for automated measurement.

◆ **High-Speed D/A Output (3169-21 only)**

The 3169-21 features D/A output for 4-channel, high-speed analog output.

◆ **Compact and light weight**

The compact size and light weight allows installation even in limited space, such as in a cubicle.

◆ **A choice of optional clamp-on sensors**

The following clamp-on sensors are compatible with the 3169-20/21.

9660 CLAMP ON SENSOR (100 A rms rating)

9661 CLAMP ON SENSOR (500 A rms rating)

9667 FLEXIBLE CLAMP ON SENSOR (5000 A rms rating)

CT9667 FLEXIBLE CLAMP ON SENSOR (5000 A rms rating)

9669 CLAMP ON SENSOR (1000 A rms rating)

9694 CLAMP ON SENSOR (5 Arms rating)

9695-02 CLAMP ON SENOSR (50 Arms rating)

9695-03 CLAMP ON SENSOR (100 Arms rating)





# Parts Names

## 2

❖4 "Connecting to Lines to be Measured" (page 37)

❖11 "Using D/A Output (3169-21 only)"  
(page 161)

Recorder, logger

❖10 "Using the External Input/  
Output Terminal" (page 155)

D/A output  
(3169-21)

❖9 "Using the Instrument with  
a Computer" (page 149)

RS-232C

PC card

❖7.2 "Using a PC Card"  
(page 121)

Printer

❖8 "Using a Printer"  
(page 141)

❖3 "Measurement Pre-  
parations" (page 25)

\*: The RS-232C is connected to a printer or PC.

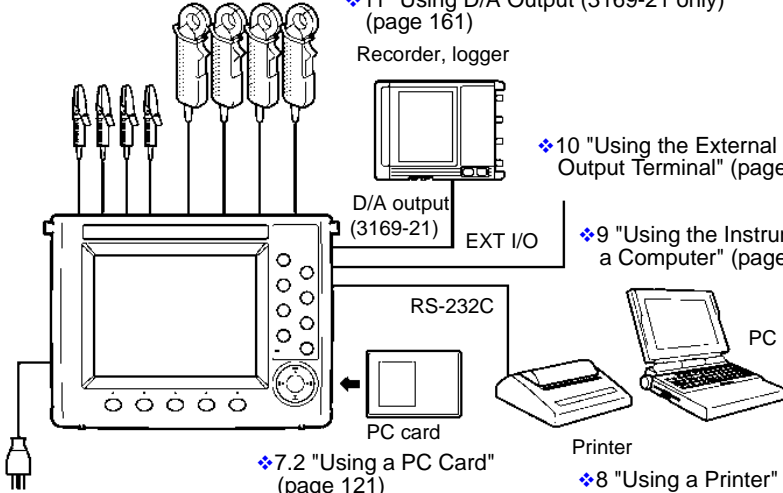

## 2.1 Instrument Labels and Functions

### Front Panel

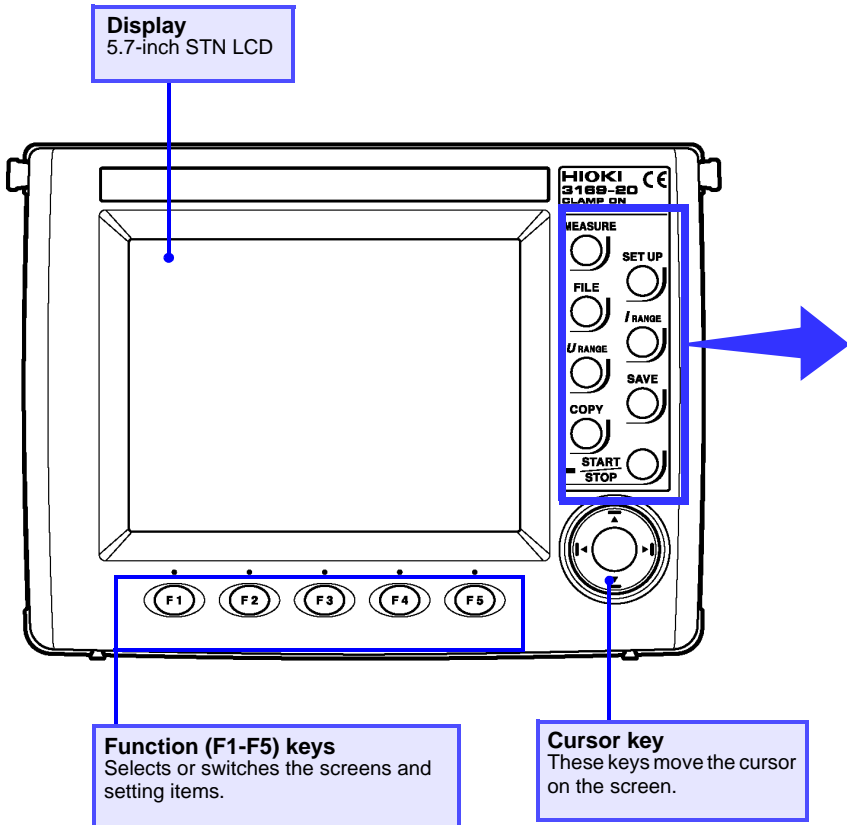

## Front Panel Enhanced View

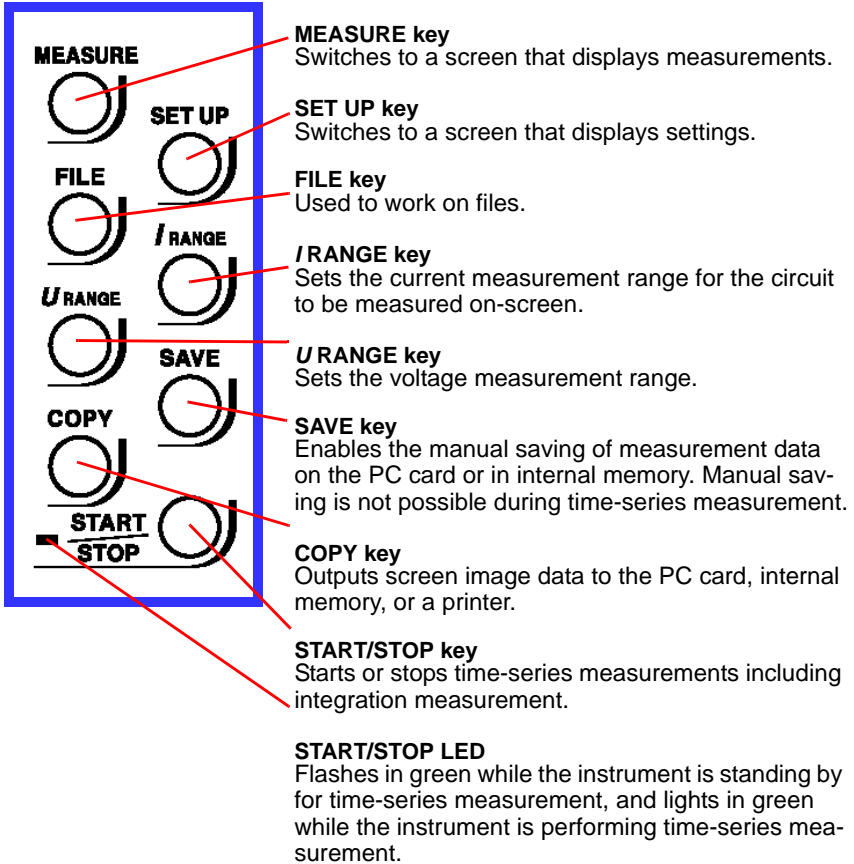

## Top Panel

### Voltage Input terminals

Connect the supplied L9438-53 Voltage Cord.

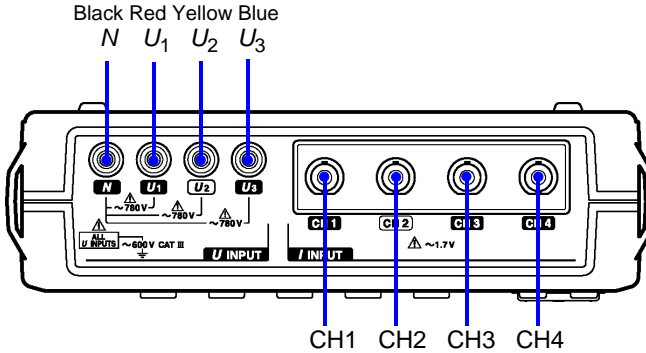

### Current Input terminals

Connect an optional clamp-on sensor.

## Left Panel

### Contrast Control Knob (CONTRAST)

Adjusts the contrast of the screen.

### KEY LOCK switch

Sliding this switch in the direction of the arrow disables all key operation except the POWER switch.

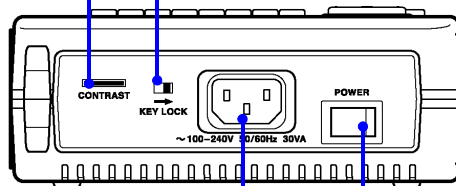

### AC Power Inlet

Connects the power cord. The supply voltage ranges from 100 V to 240 V.

### POWER switch

Turns the instrument on and off.

○ : Power OFF  
| : Power ON

## Right Panel

### PC Card slot

A PC Card can be inserted here.

### RS-232C Interface connector

Connects to a PC or printer using an RS-232C cable.

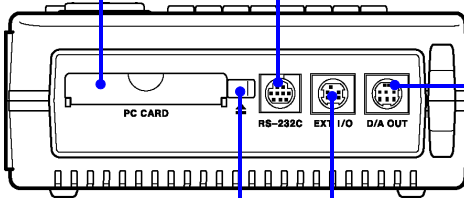

### D/A Output Terminal (D/A OUT)

Installed in the 3169-21 only. Connects the supplied 9441 connection cable. Used for analog output.

### Eject button

Press this button to eject a PC Card from the slot.

### External Input/Output Terminal (EXT I/O)

Connects the optional 9440 connection cable. Used to start and stop time-series measurement, and control data storage on the PC card.

## Rear Panel

### Number plate

Contains manufacturer's ID numbers. Please do not remove, as this information is required for product management.

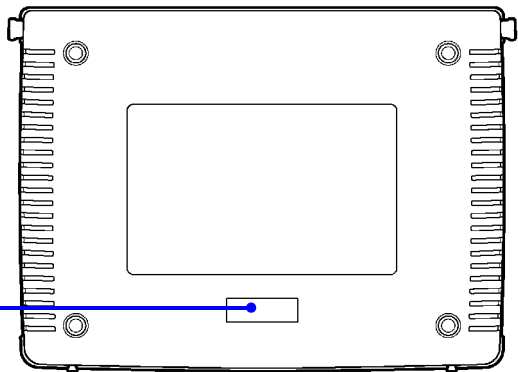

## 2.2 Screen Names and Display Elements

### 2.2.1 Screen Configuration

The screens are divided into three basic types: measurement screens, setting screens, and file screens. Each screen is selected using three panel keys: **MEASURE**, **SET UP**, and **FILE**.

Measurement screen

<b>MAIN</b> <b>POWER</b> <b>INTEGRATE</b> <b>DEMAND</b> <b>ZOOM</b> <b>HARMONIC LIST</b> <b>HARMONIC GRAPH</b> <b>WAVEFORM</b> <b>WIRING CHECK</b> <b>WIRING DIAGRAM</b>	MAIN	INST.	CIRCUIT1	2002/05/19 19:12:21	
	U1	201.09 V	I1	9.092 A	U × 300V × 1.00
	U2	201.09 V	I2	9.096 A	I × 10A
	U3	200.97 V	I3	9.094 A	× 1.00
	Uave	201.05 V	Iave	9.094 A	I4 × 1.00
			I4	0.1378 A	WIRING 3F4W41
	P1	1.5864kWh	Q	2.7221kvar	CIRCUIT ×1
	P2	1.5883kWh	S	5.4850kVA	PLL U1 50Hz
	P3	1.5866kWh	PF	0.8682	INTVL. min
	P	4.7616kWh	f	49.998 Hz	SCREEN
WP+	0.00000kWh		0:00:00	AVERAGE	
				HOLD	



FILE MAIN	2002/07/24 19:22:02
<b>INTERNAL SETTINGS</b>	
INTERNAL MEMORY	
PC CARD	
FIRMWARE UPDATE	
SELECT	



SET UP	1/5 MEASUREMENT	2002/07/24 19:08:18		
WIRING	1P2W ×4			
SAMPLING	PLL 50Hz			
VAR METHOD	OFF			
AVERAGE TIMES	1			
VOLTAGE	U1			
RANGE	300 V			
VT(PT)	0001.00			
CURRENT	CH1	CH2	CH3	CH4
RANGE	100 A	500 A	5 A	10 A
CT	0001.00	0001.00	0001.00	0001.00
SENSOR	9661	9661	9660	9660
change				NEXT SCR

**INTERNAL SETTINGS**  
**INTERNAL MEMORY**  
**PC CARD**  
**FIRMWARE UPDATE**

**MEASUREMENT**  
**DATA OUTPUT**  
**SAVE, PRINT ITEMS**  
**SYSTEM**  
**D/A OUTPUT (3169-21 only)**

## 2.2.2 Common Display

This section of the screen shows information common to all measurement screens (except the zoom screen and the wiring diagram screen).

**Common Display**









MAIN	INST.	CIRCUIT1	2002.05/19 17:12:21
U1	201.09 V	I1 9.092 A	U 300V × 1.00
U2	201.09 V	I2 9.096 A	I 10A × 1.00
U3	200.97 V	I3 9.094 A	I4 30 × 1.00
Uave	201.05 V	Iave 9.094 A	WIRING 3P4W4I
		I4 0.1378 A	CIRCUIT x1
P1	1.5864kW	Q 2.7221kvar	PLL U1 50Hz
P2	1.5888kW	S 5.4850kVA	INTVL. 1min
P3	1.5866kW	PF 0.8682	
P	4.7618kW	f 49.998 Hz	
WP+	0.00000kWh	0:00:00	
SCREEN	AVERAGE	HOLD	











Annotations in the image point to the following elements:

- Time: 2002.05/19 17:12:21
- Range: U 300V, I 10A, I4 30
- Wiring: WIRING 3P4W4I
- No. of circuits: CIRCUIT x1
- Synchronization method: PLL U1 50Hz
- Interval: INTVL. 1min

Time	Displays the current time.
Range	Displays the voltage range and current range of the on-screen circuit. The VT(PT) ratio and CT ratio are shown under these ranges. The current range and CT ratio of I4 are shown only when 3P4W4I is set as the wiring method.
Wiring	Displays the wiring method set on the setting screen.
No. of circuits	Displays the number of circuits to be measured as set on the setting screen.
Synchronization method	Displays the synchronization method and frequency of the line to be measured as set on the setting screen.
Interval	Displays the interval set on the setting screen.

## 2.2.3 On-Screen Indicators

MAIN	INST.	CIRCUIT1	VAR	2002/06/25 14:05:58
U1 over V	I1 over A	U 150V		x 1.00
U2 over V	I2 over A	I 5A		x 1.00
U3* over V	I3* over A	WIRING 3P3W2M		
Uave over V	Iave over A	CIRCUIT x2		
P over kW	Q over kvar	PLL U1 50Hz		
	S over kVA	INTVL. 1min		
	PF over			
	f 50.000 Hz			
WP+ 0.000 Wh	0:00:00			
SCREEN	CIRCUIT AVERAGE	HOLD		

	Goes on when the reactive-power-meter method is ON.
	Goes on when the displayed measurement is held.
	Goes on when the medium for saving data is set to PC card. Flashes when the PC card is accessed.
	Goes on when the medium for saving data is set to internal memory. Flashes when the internal memory is accessed.
	Goes on when the PC card or internal memory is full.
	Goes on when the device to be connected to the RS-232C is set to PC.
	Goes on when the device to be connected to the RS-232C is set to printer.
	Goes on when the PLL is unlocked; the synchronization method is automatically switched over to the fixed clock.
	Goes on when the keys are locked.
	Goes on when the voltage or current dynamic range is exceeded.
over	Displayed when the range is exceeded.

### NOTE

U3\* and I3\* indicate that the data is obtained by calculating the 2-voltage, 2-current measurement results when 3P3W2M (three-phase, 3-wire, 2-power-meter method) is selected.

❖ "Appendix" (page 203)



# Measurement Preparations

3

Please read the Usage Notes (page 7) before setting up this instrument.

## 3.1 Banding the L9438-53 Voltage Cord

5 Spiral Tubes provided with Model L9438-53 Voltage Cord.  
Use the Spiral Tubes as and when required.

### Required Equipment

#### L9438-53 Voltage Cord

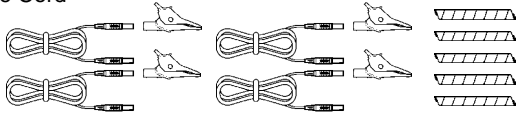

Alligator Clip	4 clips (red, yellow, blue, and black /1 each)
Test Leads	4 cords (red, yellow, blue, and black /1 each)
Spiral Tube	5 pieces (for banding the cords)

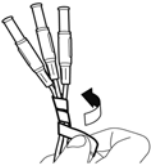

### 1. Gather the multiple cords

Gather one end of the multiple cords together so that it is easier to band.

Single-phase 2-wire(1P2W)	2cords(black,red)
Single-phase 3-wire(1P3W)	3cords(black,red,yellow)
Three-phase 3-wire(3P3W2M)	3cords(black,red,yellow)
Three-phase 3-wire(3P3W3M)	3cords(black,red,blue)
Three-phase 4-wire(3P4W)	4cords(black,red, Yellow,blue)

### How to use the Spiral Tube

- Wind a Spiral Tube round the multiple cords.  
5 Spiral Tubes are provided.  
Please wind the tubes at appropriate intervals.

Example: Single-phase 3-wire(1P3W) or Three-phase 3-wire(3P3W2M)

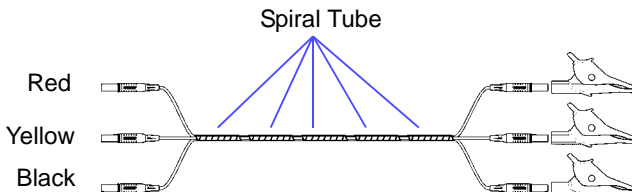

3

3.1 Banding the L9438-53 Voltage Cord

## 3.2 Pre-Operation Inspection

Before using the instrument the first time, verify that it operates normally to ensure that no damage occurred during storage or shipping. If you find any damage, contact your authorized Hioki distributor or reseller.

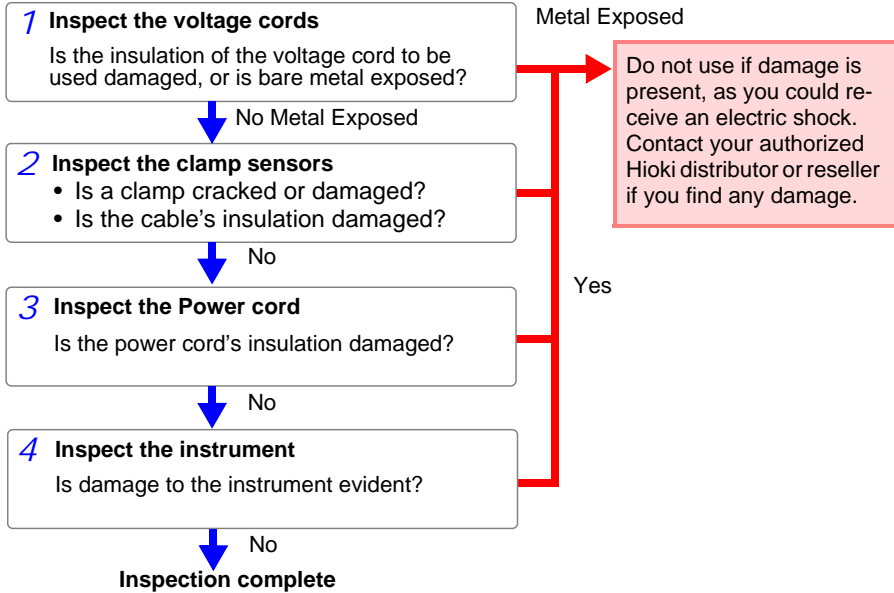

## 3.3 Connection Procedure

Refer to the indicated reference items before installing and connecting.

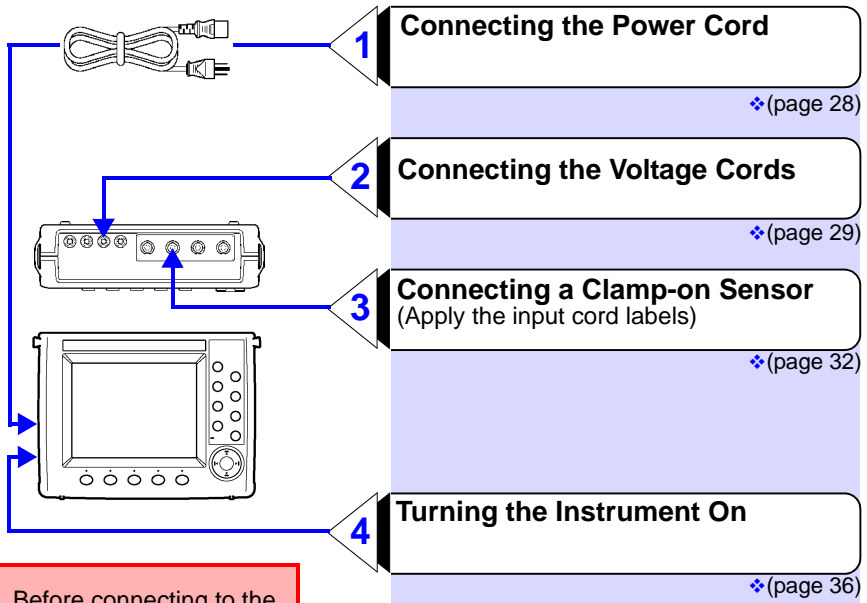

Before connecting to the lines to be measured, be sure steps 1 - 4 have been completed.

Connect to the lines to be measured  
❖ 4 Connecting to Lines to be Measured  
(page 37)

## 3.4 Connecting the Power Cord



### WARNING

- Before turning the product on, make sure the source voltage matches that indicated on the product's power connector. Connection to an improper supply voltage may damage the product and present an electrical hazard.
- To avoid electric shock and ensure safe operation, connect the power cable to a grounded (3-contact) outlet.
- Use only the designated power cord with this instrument. Use of other power cords may cause fire.

### Connecting the Power Cords

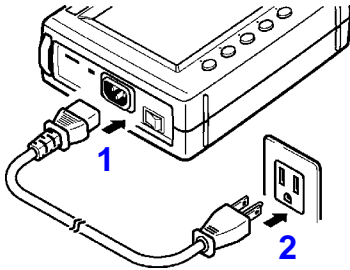

1. Connect the power cord to the AC power inlet.
2. Plug the power cord into the AC mains outlet.

## 3.5 Connecting the Voltage Cords



### DANGER

Connect the voltage cords to the product first, and then to the active lines to be measured. Observe the following to avoid electric shock and short circuits.

- Voltage cord should only be connected to the secondary side of a breaker, so the breaker can prevent an accident if a short circuit occurs. Connections should never be made to the primary side of a breaker, because unrestricted current flow could cause a serious accident if a short circuit occurs.
- Do not allow the voltage cord clips to touch two wires at the same time. Never touch the edge of the metal clips.
- Voltage input terminals  $U_1$ ,  $U_2$ , and  $U_3$  are common to the N terminal and are not insulated. To avoid the risk of electric shock, do not touch the terminals.

## CAUTION

- For safety reasons, when taking measurements, only use the L9438-53 Voltage Cord provided with the product.
- For details of the Voltage Cords provided with this product, refer to the illustration below. Use the Spiral Tubes as as and when required.
- ❖ Refer to 3.1 Banding the L9438-53 Voltage Cord (page 25)

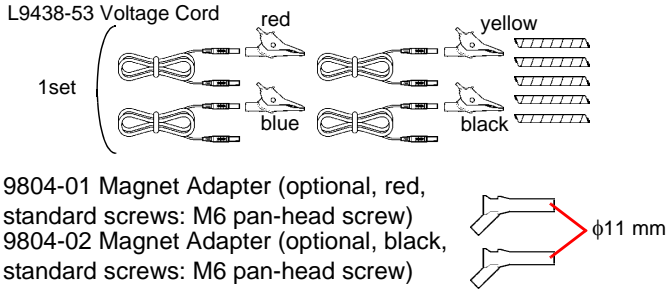

## NOTE

Be sure to hold the voltage cord by its plug when connecting or disconnecting the cable.

## Connecting the voltage cords to the instrument

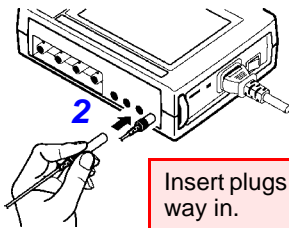
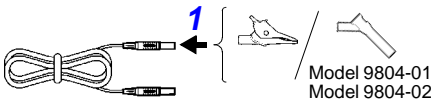

1. Connect the Alligator Clip or Model 9804-01, 9804-02 Magnetic Adapter Set (optional) to the Test Leads. Insert it until it stops.
2. Connect the voltage codes to the voltage input terminals. The required number of the codes varies depending on the wiring method to be measured.

## Voltage cords and measurement lines

## Single-phase 2-wire (1P2W)

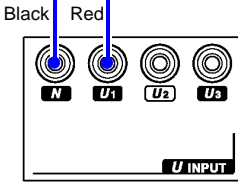

Measurement Line type

Voltage input terminals

## Single-phase 3-wire (1P3W)

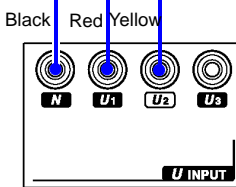

## Three-phase 3-wire (3P3W2M)

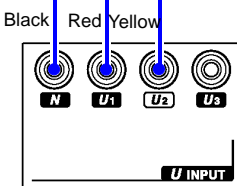

## Three-phase 3-wire (3P3W3M)

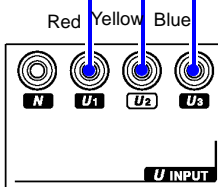

## Three-phase 4-wire (3P4W, 3P4W4I)

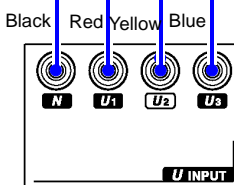

## 3.6 Using a Clamp-On Sensor (Option)



### DANGER

Connect the clamp-on sensors to the product first, and then to the active lines to be measured. Observe the following to avoid electric shock and short circuits.

- Clamp sensor should only be connected to the secondary side of a breaker, so the breaker can prevent an accident if a short circuit occurs. Connections should never be made to the primary side of a breaker, because unrestricted current flow could cause a serious accident if a short circuit occurs.
- When the clamp sensor is opened, do not allow the metal part of the clamp to touch any exposed metal, or to short between two lines, and do not use over bare conductors.
- To prevent damage to the product and sensor, never connect or disconnect a sensor while the power is on.
- The current input terminals of the 3169-20/21 are not insulated. To avoid the risk of electric shock, only use the specified optional clamp-on sensor.

Use Hioki clamp-on sensor 9660, 9661, 9667, CT9667, 9669, 9694, or 9695-02/03.

### 3.6.1 Clamp-On Sensor Specifications

Refer to the Instruction Manual for the specific model for more details.

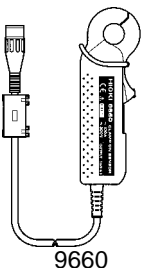

9660

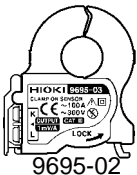

9695-02

#### 9660 CLAMP ON SENSOR/ 9695-02 CLAMP ON SENSOR

Rated primary current	100 A AC
Output voltage	1 mVAC/A
Maximum permissible input	130 A continuous (at 45 to 66 Hz, 50°C)
Amplitude accuracy	±0.3%rdg. ±0.02%f.s. (f.s.=100 A, 45 to 66 Hz)
Phase accuracy	Within ±1° (45 Hz to 5 kHz)
Amplitude frequency characteristics	Within ±1% at 40 Hz to 5 kHz (deviation from accuracy)
Maximum rated voltage to earth	300 Vrms
Measurable conductor diameter	15 mm max.
Operating temperature and humidity	0 to 50°C (32°F to 122°F), 80% RH or less (no condensation)
Option	9219 CONNECTION CABLE (for 9695-02/03)



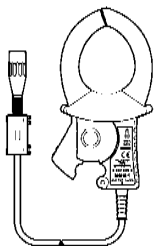

### 9661 CLAMP ON SENSOR

Rated primary current	500 A AC
Output voltage	1 mVAC/A
Maximum permissible input	550 A continuous (at 45 to 66 Hz, 50°C)
Amplitude accuracy	$\pm 0.3\%$ rdg. $\pm 0.01\%$ f.s. (f.s.=500 A, 45 to 66 Hz)
Phase accuracy	Within $\pm 0.5^\circ$ (45 Hz to 5 kHz)
Amplitude frequency characteristics	Within $\pm 1\%$ at 40 Hz to 5 kHz (deviation from accuracy)
Maximum rated voltage to earth	600 Vrms
Measurable conductor diameter	46 mm max.
Operating temperature and humidity	0 to 50°C (32°F to 122°F), 80% RH or less (no condensation)

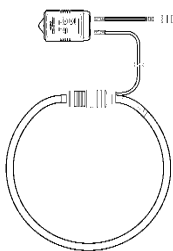

### CT9667 FLEXIBLE CLAMP ON SENSOR

Rated primary current	500 A AC/ 5000 A AC
Output voltage	500 mV AC f.s. (1 mVAC/A) 500 mV AC f.s. (0.1 mVAC/A)
Maximum permissible input	10000 A continuous at 45 to 66 Hz
Amplitude accuracy	$\pm 2.0\%$ rdg. $\pm 0.3\%$ f.s. (45 to 66 Hz)
Phase accuracy	Within $\pm 1^\circ$ (45 to 66 Hz)
Amplitude frequency characteristics	Within $\pm 3$ dB, 10 Hz to 20 kHz
Maximum rated voltage to earth	1000 Vrms
Measurable conductor diameter	254 mm max.
Operating temperature and humidity	0 to 40°C (32°F to 104°F), 80% RH or less (no condensation)
Power supply	LR03 alkaline battery x 4 or 9445-02/03 AC ADAPTER

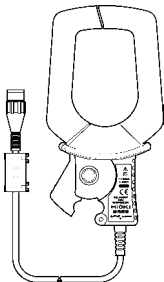

### 9669 CLAMP ON SENSOR

Rated primary current	1000 A AC
Output voltage	0.5 mVAC/A
Maximum permissible input	1000 A continuous (at 45 to 66 Hz, 50°C)
Amplitude accuracy	$\pm 1.0\%$ rdg. $\pm 0.01\%$ f.s. (f.s.=1000 A, 45 to 66 Hz)
Phase accuracy	Within $\pm 1^\circ$ (45 Hz to 5 kHz)
Amplitude frequency characteristics	Within $\pm 2\%$ at 40 Hz to 5 kHz (deviation from accuracy)
Maximum rated voltage to earth	600 Vrms
Measurable conductor diameter	55 mm max.
Operating temperature and humidity	0 to 50°C (32°F to 122°F), 80% RH or less (no condensation)

### 3.6 Using a Clamp-On Sensor (Option)

#### 9694 CLAMP ON SENSOR/ 9695-03 CLAMP ON SENSOR

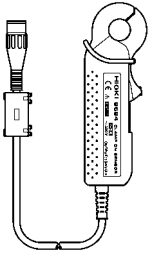

9694

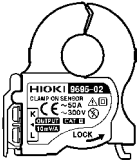

9695-03

Rated primary current	9694: 5 A AC/ 9695-03: 50 A AC
Output voltage	10 mVAC/A
Maximum permissible input	9694: 50 A continuous (at 45 to 66 Hz , 50°C) 9695-02: 60 A continuous (at 45 to 66 Hz , 50°C)
Amplitude accuracy	9694: $\pm 0.3\%$ rdg. $\pm 0.02\%$ f.s.(f.s.=5 A, 45 to 66 Hz) 9695-02: $\pm 0.3\%$ rdg. $\pm 0.02\%$ f.s. (f.s.=5 A, 45 to 66 Hz)
Phase accuracy	Within $\pm 2^\circ$ (45 Hz to 5 kHz)
Amplitude frequency characteristics	Within $\pm 1\%$ at 40 Hz to 5 kHz (deviation from accuracy)
Maximum rated voltage to earth	300 Vrms
Measurable conductor diameter	15 mm max.
Operating temperature and humidity	0 to 50°C (32°F to 122°F), 80% RH or less (no condensation)
Option	9219 CONNECTION CABLE (for 9695-02/03)

## 3.6.2 Connecting a Clamp-on Sensor

### Connecting a Clamp Sensor to the Instrument

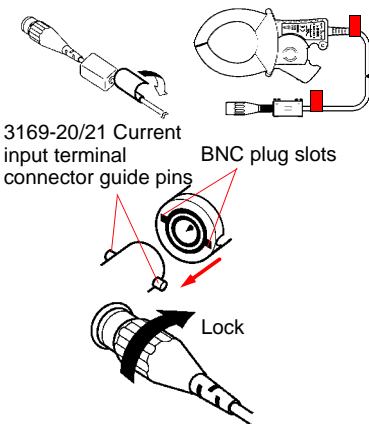

1. At each end of the cable, apply the input cord labels having the same color as the current input terminal to which it is to be connected.
2. Align the slots in the BNC plug with the guide pins on the connector at the instrument side, then push and turn the plug clockwise.  
(to unplug the connector, push the plug and turn it counterclockwise before pulling it apart.)

#### NOTE

When disconnecting the BNC connector, be sure to release the lock before pulling the connectors apart. Forcibly pulling the connector without releasing the lock, or pulling on the cable, can damage the connector.

### Clamp-on sensors and measurement lines

**Single-phase 2-wire (1P2W)**

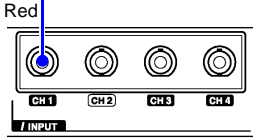

**Single-phase 3-wire (1P3W)**

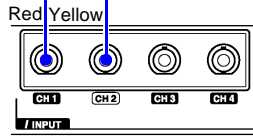

Measurement Line type

Current Input terminals

**Three-phase 3-wire (3P3W2M)**

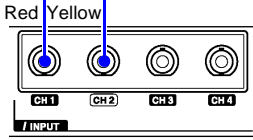

**Three-phase 3-wire (3P3W3M)**

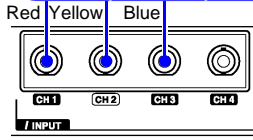

**Three-phase 4-wire (3P4W)**

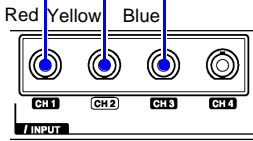

**Three-phase 4-wire (3P4W4I)**

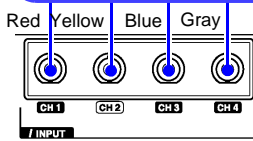

**Single-phase 2-wire X 4 (1P2W X 4)**

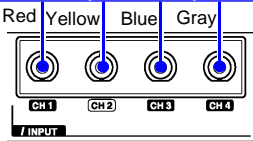

**Single-phase 3-wire X 2 (1P3W X 2)**

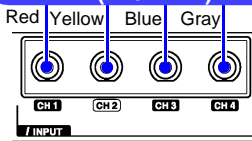

**Three-phase 3-wire X 2 (3P3W2M X 2)**

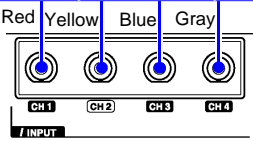

## 3.7 Turning the Power On/Off



**WARNING** Before turning the product on, make sure the source voltage matches that indicated on the product's power connector. Connection to an improper supply voltage may damage the product and present an electrical hazard.

### Turning the Instrument On/Off

#### Powering On

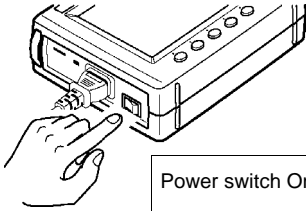

Turn the POWER switch ON ( | ).

As soon as the power is turned on, the self-test screen appears. Upon completion of the self test, display switches to the measurement screen.

Screen after the power is turned on (Self-test screen)

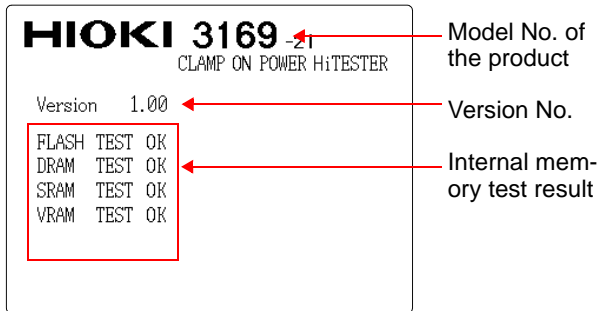

#### Powering Off

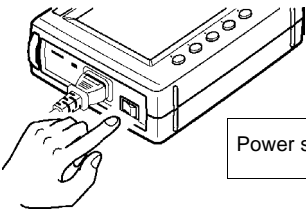

Turn the POWER switch OFF ( ○ ).

#### NOTE

If an error occurs during self-testing, the instrument may be damaged. Contact your dealer or HIOKI representative.

# Connecting to Lines to be Measured

## 4

Please read the Usage Notes (page 7) before making connections.

### 4.1 Connection Procedure

- ❖ 3.5 Connecting the Voltage Cords (page 29)
- ❖ 3.6 Using a Clamp-On Sensor (Option) (page 32)
- ❖ 3.7 Turning the Power On/Off (page 36)

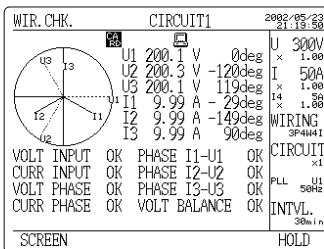
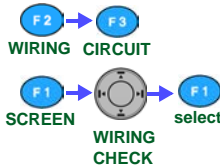
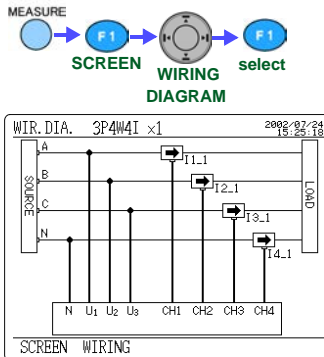

**1** Verify that the voltage cord or clamp-on sensor is properly connected to the input terminals.

**2** Turn on ( | ) the 3169-20/21.

**3** Select the wiring diagram screen on the measurement screen to view the wiring diagram.

❖ (page 38)

**4** Set the wiring method and number of circuits by using the F2 (WIRING) and F3 (CIRCUIT) keys.

❖ (page 38)

**5** Connect the voltage cords and clamp-on sensor to the lines to be measured in accordance with the displayed wiring diagram.

❖ (page 50)

**6** Select the wiring check screen to check the current connection.

❖ (page 52)

OK To 7 NG To 5

**7** Set the parameters on the setting screen.

❖ 5 Setting Procedure (page 59)

**Measurement**

❖ 6 Measurement Method (page 99)

## 4.2 Connection Methods

### 4.2.1 Displaying the Wiring Diagram

MEASURE



Press the **MEASURE** key to display the measurement screen.



SCREEN

Press the **F1** (SCREEN) key to display the selection window.



Select "WIRING DIAGRAM" by using the cursor key.



select

Press the **F1** (select) key; the wiring diagram will appear.

(Example: 3P3W2M x 1 (three-phase, 3-wire))

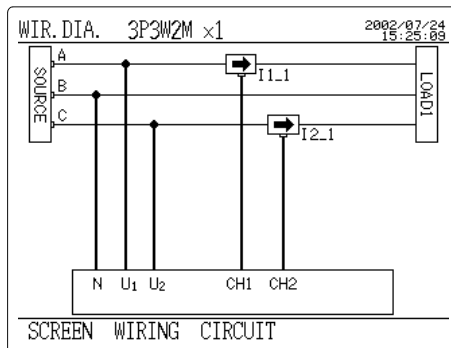

Wiring diagram screen

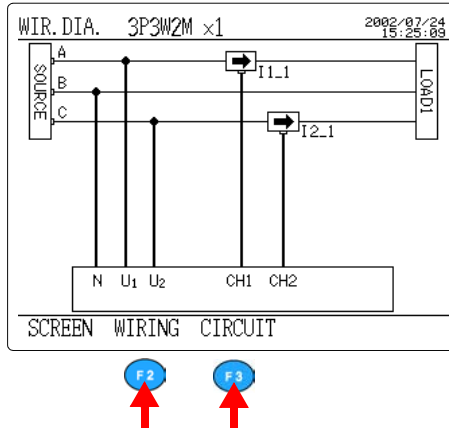

## (1) Set the Wiring Method.

**F2** WIRING Press the **F2** (WIRING) key to display the selection window.

1P2W	Measurement of a single-phase, 2-wire line
1P3W	Measurement of a single-phase, 3-wire line
3P3W2M	Measurement of a three-phase, 3-wire line (by the two-power-meter method) *: Select this method to measure three-phase power by measuring the current at two positions only.
3P3W3M	Measurement of a three-phase, 3-wire line (by the three-power-meter method)
3P4W	Measurement of a three-phase, 4-wire line
3P4W4I	Measurement of a three-phase, 4-wire line (used for neutral conductor measurement)

Select a wiring method by using the cursor key.

**F1** select Press the **F1** (select) key.

## (2) Set the Number of Circuits (when measuring multiple circuits).

 **CIRCUIT** Press the **F3** (CIRCUIT) key to display the selection window.

1P2W	1 (1 circuit), 2 (2 circuits), 3 (3 circuits), 4 (4 circuits)
1P3W	1 (1 circuit), 2 (2 circuits)
3P3W2M	1 (1 circuit), 2 (2 circuits)
3P3W3M,3P4W, 3P4W4I	1 (1 circuit)



Select a number of circuits by using the cursor key.

 **select** Press the **F1** (select) key.



## 4.2.2 Basic Wiring for Single-Circuit Measurement

### Single-phase 2-wire (1P2W)

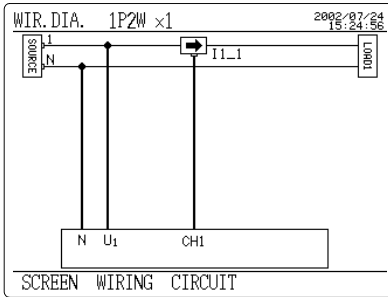

Wiring diagram screen

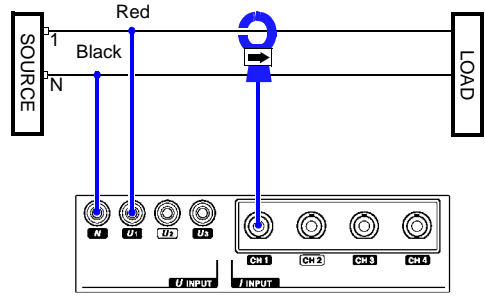

Face the arrow toward the Load

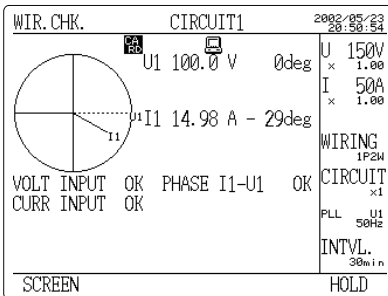

Wiring check screen (Power factor: 0.87)

❖ 4.2.5 Checking the Wiring (page 52)

## Single-phase 3-wire (1P3W)

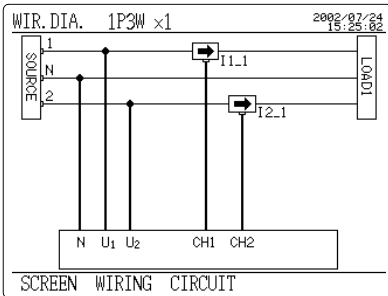

Wiring diagram screen

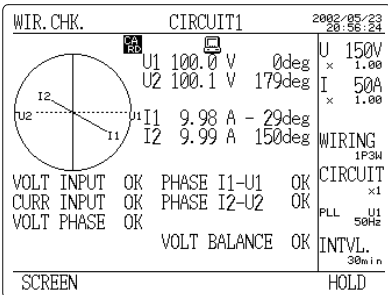
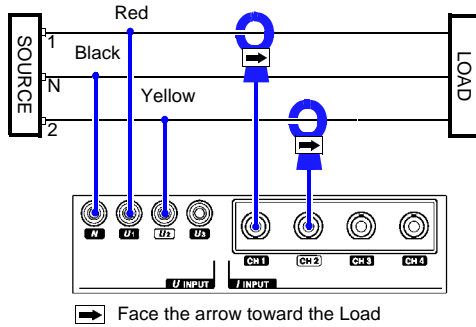

Wiring check screen (Power factor: 0.87)

❖4.2.5 Checking the Wiring (page 52)

Three-phase 3-wire (3P3W2M) 2-Power-Meter Method

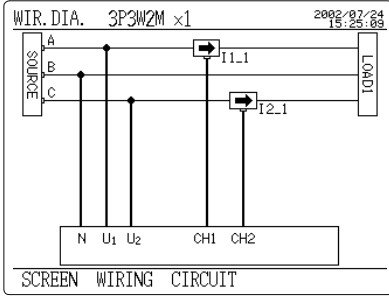

Wiring diagram screen

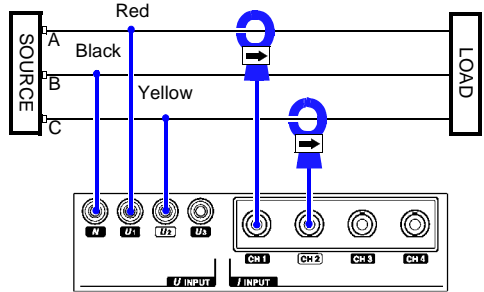

➡ Face the arrow toward the Load

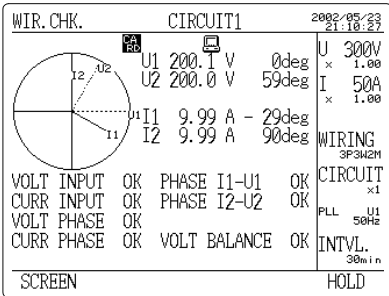

Wiring check screen (Power factor: 1)

❖ 4.2.5 Checking the Wiring (page 52)

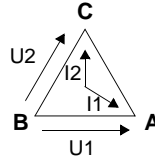

Three-phase 3-wire (3P3W3M) 3-Power-Meter Method

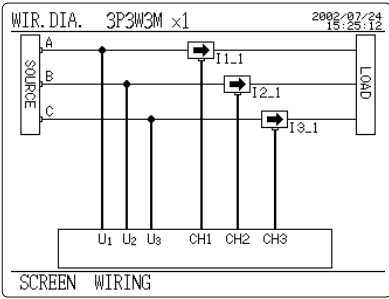

Wiring diagram screen

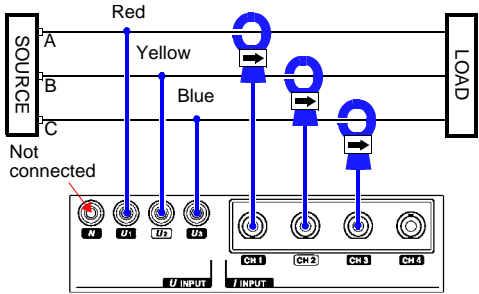

➡ Face the arrow toward the Load

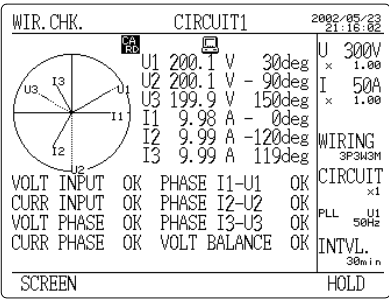

Wiring check screen (Power factor: 1)

❖4.2.5 Checking the Wiring (page 52)

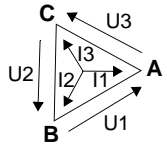

Three-phase 4-wire (3P4W)

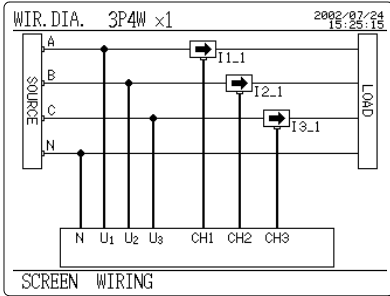

Wiring diagram screen

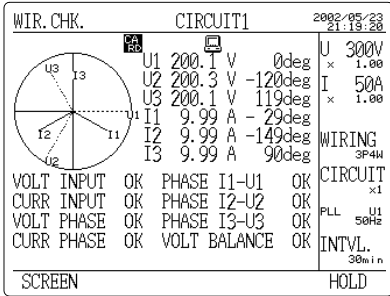
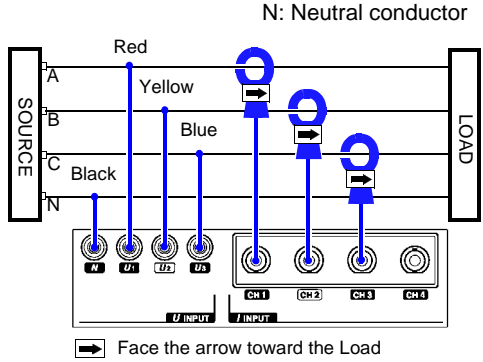

Wiring check screen (Power factor: 0.87)

❖4.2.5 Checking the Wiring (page 52)

Three-phase 4-wire (3P4W4I) Neutral Current Measurement

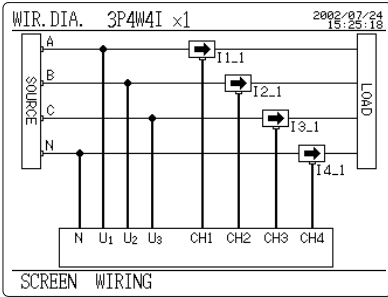

Wiring igrum screen

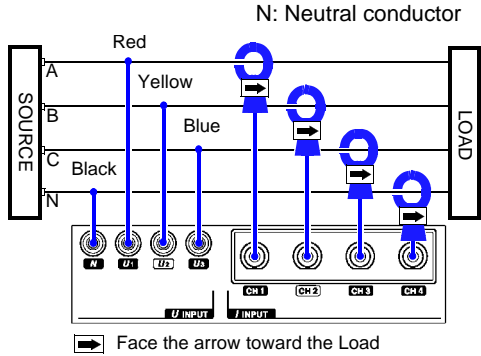

➡ Face the arrow toward the Load

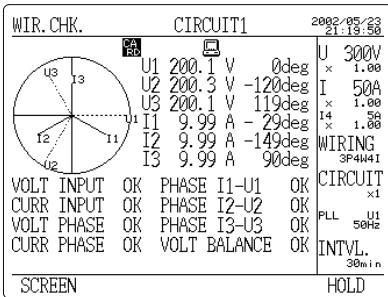

The connection for neutral current I4 is not checked.

Wiring check screen (Power factor: 0.87)

❖ 4.2.5 Checking the Wiring (page 52)

## 4.2.3 Wiring for Multiple-Circuit Measurement

### NOTE

- One 3169-20/21 unit can measure multiple circuits of the same voltage system (same transformer).
- The wiring mode is common to all circuits.
- Measurements of the current channels will not be zeroed when the device is not connected to the clamp-on sensor.

### Single-phase 2-wire, 4circuits (1P2W X 4)

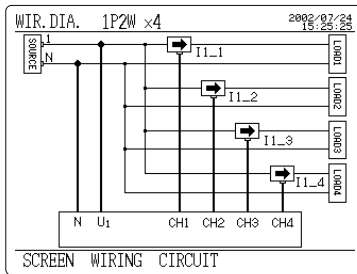

Wiring diagram screen

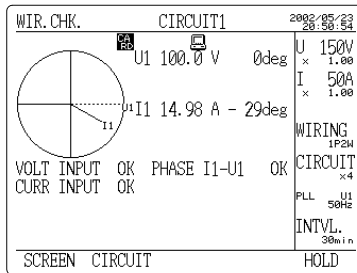

**F2** changes the circuit to display.

Wiring check screen (Power factor: 0.87)

❖ 4.2.5 Checking the Wiring (page 52)

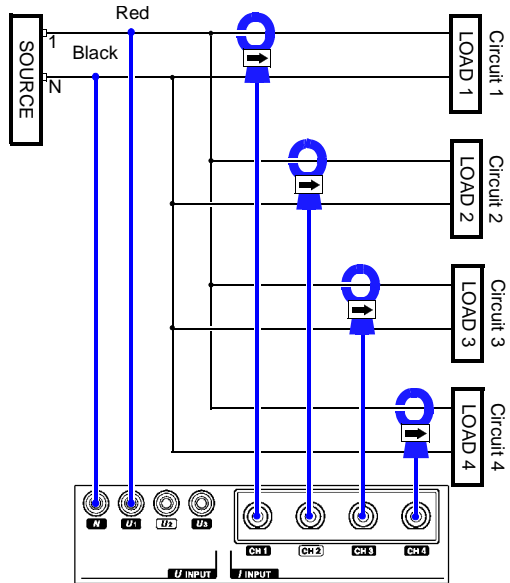

➡ Face the arrow toward the Load

## Single-phase 3-wire, 2circuits (1P3W X 2)

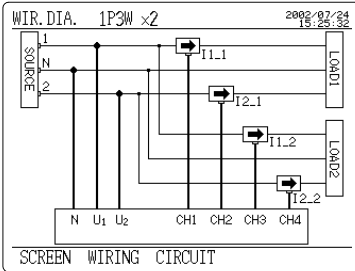

Wiring diagram screen

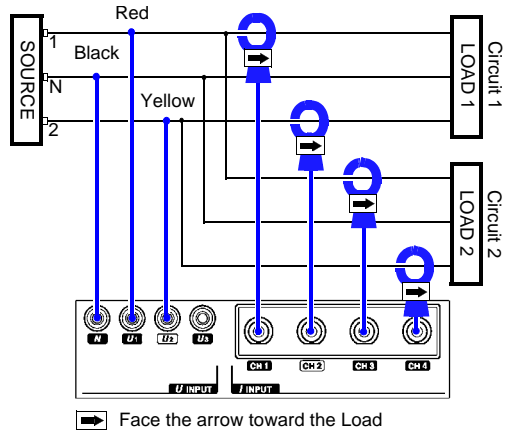
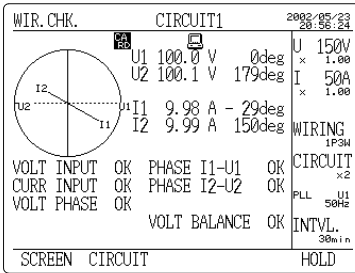

**F2** changes the circuit to display.

Wiring check screen (Power factor: 0.87)

❖ 4.2.5 Checking the Wiring (page 52)



Three-phase 3-wire, 2circuits (3P3W2M X 2) 2-Power-Meter Method

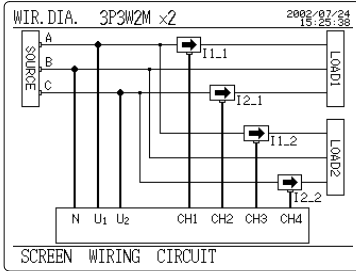

Wiring diagram screen

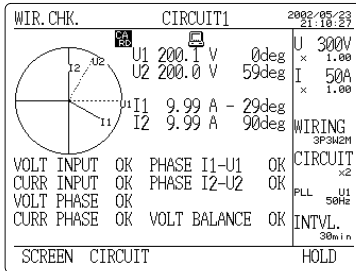

**F2** changes the circuit to display.

Wiring check screen (Power factor: 1)

❖4.2.5 Checking the Wiring (page 52)

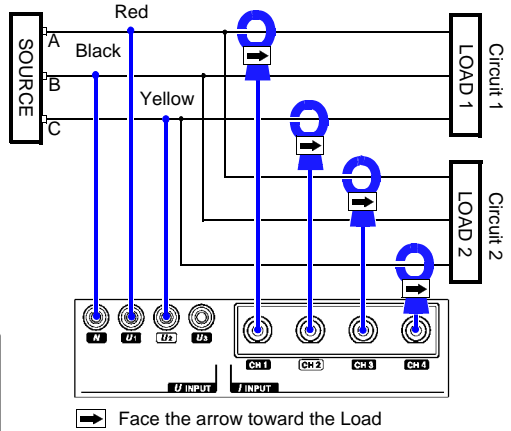

### 4.2.4 Connection to a Line to Be Measured

Connect the voltage cords and clamp-on sensor to the line to be measured, while referring to the wiring diagram.

#### NOTE

To ensure correct measurement results, follow the instrument setup and wiring instructions precisely.

#### Connecting the Voltage Cords to the Lines to be Measured

**(Example)** When using an Alligator Clip

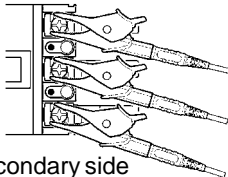

Clip the metallic parts on the secondary side of the breaker, such as the screws and bars for the wires.

Secondary side  
of the breaker

L9438-53 Voltage Cord

**(Example)**

When using Model 9804-01,02 (optional, Standard screws: M6 pan-head screw)

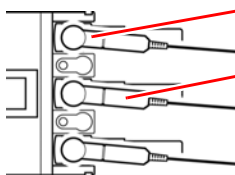

9804-01,02 Magnet Adapter

L9438-53 Voltage Cord

Connect the magnetic tip of the 9804-01, 02 Magnet Adapter (optional) to the screws on the secondary side of the breaker.

Secondary side  
of the breaker

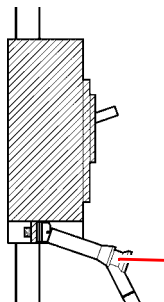

Depending on the weight of the voltage cord, the 9804-01, 02 Magnet Adapter sometimes cannot connect to the screws perpendicularly. When this happens, make a right-angle connection to maintain the balance. Check the voltage current to make sure that the connection is made.

9804-01,02 Magnet Adapter

L9438-53 Voltage Cord

Secondary side  
of the breaker

## Clamping a Sensor to a Line to be Measured

(Example: 9660)

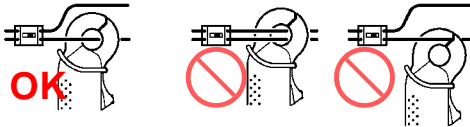

Clamp around only one conductor. Measurement is not possible if the clamp is placed around two lines in a single-phase circuit, or three lines in a three-phase circuit.

(Example: 9660)

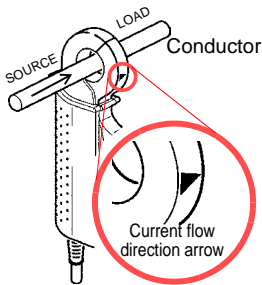

(Example: 9661)

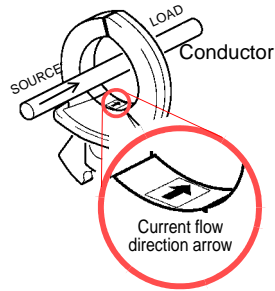

The arrows on the clamp indicating the direction of current flow should point toward the load side.

## 4.2.5 Checking the Wiring

Check to see if the 3169-20/21 is correctly connected to the line to be measured.

MEASURE



Press the **MEASURE** key to display the measurement screen.



SCREEN

Press the **F1** (SCREEN) key to display the selection window.



Select "WIRING CHECK" by using the cursor key.



select

Press the **F1** (select) key; the wiring check will appear. The connection status is shown by the voltage, current vectors, and the connection check result.

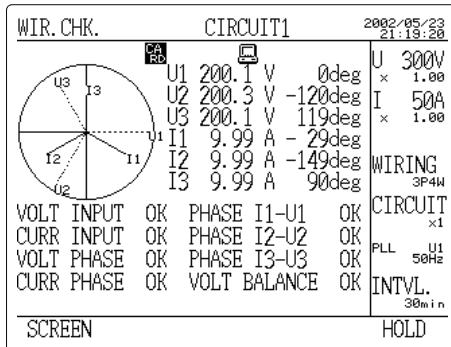

### NOTE

- The wiring check function may indicate incorrect connection even when the actual connection is correct, or vice versa. Check the vectors and measurements as well.
- The length of a vector is not related to input level. It only indicates the phase relationship.
- A minus sign (-) with the phase angle indicates a lag phase angle; a plus sign (+) indicates a lead phase angle. The phase angle is calculated using the phase of the fundamental of the PLL source ( $U_1$ ) as a reference.
- The voltage levels, current levels, and phase angles displayed on-screen are those of the fundamental component and different from RMS value.

## (1) Display the Screen of Another Circuit (when measuring multiple circuits).

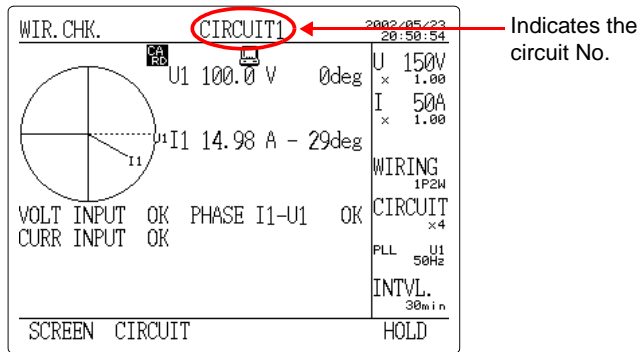

**F2** CIRCUIT

Pressing the **F2** (CIRCUIT) key repeatedly changes the circuit on the screen as follows:

"Circuit 1" → "Circuit 2" → "Circuit 3" → "Circuit 4"



(Up to Circuit 2 when 1P3W or 3P3W2M is selected.)

## (2) Change the Voltage Range.

**U RANGE**



Pressing the **U Range** key repeatedly changes the range as follows:

"150 V" → "300 V" → "600 V"



### (3) Change the Current Range.



Pressing the **I RANGE** key repeatedly changes the range for the circuit on the screen as follows:

When using the 9660/9695-03:	"5 A" → "10 A" → "50 A" → "100 A" ↑ └──────────────────────────┘
When using the 9661:	"5 A" → "10 A" → "50 A" → "100 A" → "500 A" ↑ └──────────────────────────┘
When using the 9667 (CT9667): 5000/500-A range	"5 kA" / "500 A" fixed
When using the 9669:	"100 A" → "200 A" → "1 kA" ↑ └──────────────────────────┘
When using the 9694:	"500 mA" → "1 A" → "5 A" ↑ └──────────────────────────┘
When using the 9695-02:	"500 mA" → "1 A" → "5 A" → "10 A" → "50 A" ↑ └──────────────────────────┘

To change the type of clamp-on sensor, display the measurement setting screen by using the **SET UP** key, then edit the setting.

❖ 5.2.9 Setting the Clamp-On Sensor (page 71)

The table below lists the wiring check items and criteria.

Wiring Check Item	Criteria
Voltage input	NG when input is less than 10% of the voltage range
Current input (except for I4 when 3P4W4I is selected)	NG when input is less than 1% of the current range
Phase difference (current - voltage)	NG when each current is not within $\pm 60$ degrees with respect to the voltage of each phase
Voltage phase	1P3W: NG when U2 is not within 180 degrees $\pm 10$ degrees with respect to U1 3P3W2M: NG when the phase lead of U2 is not within 60 degrees $\pm 10$ degrees with respect to U1 3P3W3M, 3P4W, 3P4W4I: NG when the phase lag of U2 is not within 120 degrees $\pm 10$ degrees with respect to U1, or when the phase lead of U3 is not within 120 degrees $\pm 10$ degrees with respect to U1
Current phase (for three-phase lines only)	NG when current phase sequence is negative
Voltage balance (except for 1P2W)	NG when one voltage is 70% or less than the other voltage



## The wiring check result is NG.

<p><b>The voltage input is NG.</b></p>	<ul style="list-style-type: none"> <li>• Are you sure that the voltage clip is connected to the metallic part of the object to be measured?</li> <li>• Is the voltage cord properly inserted into the voltage input terminal of the 3169-20/21?</li> <li>• Is the voltage cord properly inserted into the voltage clip?</li> </ul>
<p><b>The current input is NG.</b></p>	<ul style="list-style-type: none"> <li>• Is the clamp-on sensor securely inserted into the current input terminals?</li> <li>• Is the set current range too large for the input level? If the current range is too large, change the current range setting to a lower range to have the measurement values more than 5% of the set range.</li> </ul>
<p><b>The voltage phase is NG.</b></p>	<ul style="list-style-type: none"> <li>• Are the voltage cords connected to the correct terminals?</li> </ul>
<p><b>The current phase is NG.</b></p>	<ul style="list-style-type: none"> <li>• Does the arrow of the clamp-on sensor point to the load side?</li> <li>• Is the clamp-on sensor connected to the correct terminals?</li> </ul>
<p><b>The phase difference (I-U) is NG.</b></p>	<ul style="list-style-type: none"> <li>• Are the voltage cords and clamp-on sensor properly connected?</li> <li>• Does the arrow of the clamp-on sensor point to the load side?</li> <li>• Is the power factor of the line to be measured too low, such as 0.5 or less? If the power factor is less than 0.5, the phase difference (I-U) will show NG even if the wires are properly connected. When the connection is visually confirmed as being appropriate, the measurement values will be correct even if a NG judgment is given.</li> </ul>
<p><b>The voltage balance is NG.</b></p>	<ul style="list-style-type: none"> <li>• Does the connection method of the line to be measured differ from that set?</li> <li>• Are you sure that the voltage clip is connected to the metallic part of the object to be measured?</li> <li>• Is the voltage cord properly inserted into the voltage input terminal of the 3169-20/21?</li> </ul>

## 4.3 Measurement Range

This unit is not equipped with an automatic range selection function, therefore you must select the operation ranges. The display and effective measurement ranges (ranges where accuracy is certain) of measurement ranges are as follows.

### Voltage Range

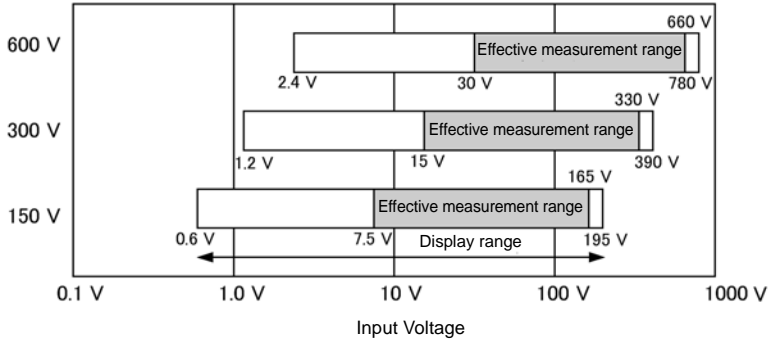

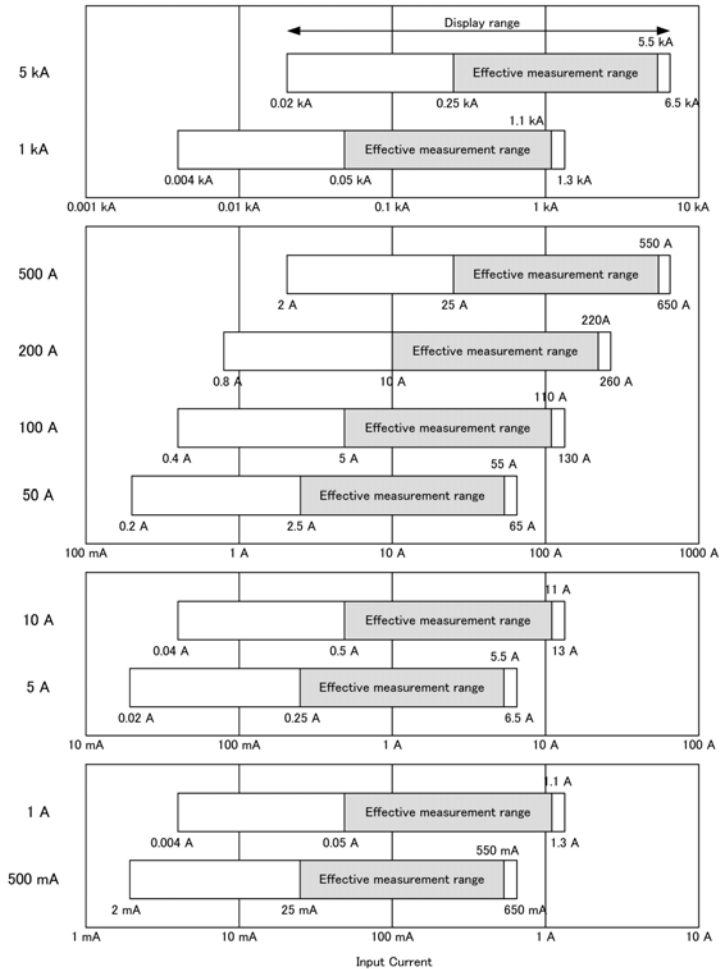

Current Range

**NOTE**

- **Dynamic range overflow warning**  
This warning is indicated when the input signal exceeds the maximum or falls below the minimum (out of crest factor) during waveform acquisition (A/D conversion). In either case, change the range setting to that with a sufficient margin. (Indicator:  $I_{low}$   $I_{ow}$ )
- **Over range**  
This warning is indicated when a measurement exceeds 130%f.s. of the range. Change the range setting to that with a sufficient margin. (Indicator: over)



# Setting Procedure

## 5

### 5.1 Setting Screen

SET UP

NEXT  
SCR

Press the **SET UP** key to display the setting screen.

SET UP 1/5 MEASUREMENT		2002/07/24 16:26:28
WIRING	IP2W	x1
SAMPLING	PLL	50Hz
VAR METHOD	OFF	
AVERAGE TIMES	1	
VOLTAGE	U1	
RANGE	300 V	
VT(PT)	0001.00	
CURRENT	CH1	
RANGE	100 A	
CT	0001.00	
SENSOR	9661	
change		NEXT SCR



Pressing the **F5** (NEXT SCR) key or **SET UP** key repeatedly switches the screen as follows:

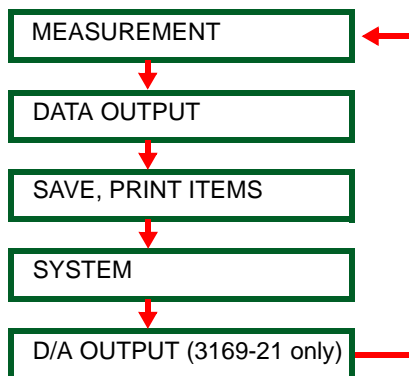

## 5.2 Setting on the Measurement Setting Screen (MEASUREMENT)

The measurement setting screen enables the items below to be set.

- Wiring method
- Number of circuits to be measured
- Synchronization method
- Reactive-power-meter method
- Display averaging times
- Voltage range
- VT (PT) ratio
- Current range
- CT ratio
- Clamp-on sensor

SET UP 1/5 MEASUREMENT		2002/07/24 16:26:28
WIRING	1P2W	×1
SAMPLING	PLL	50Hz
VAR METHOD	OFF	
AVERAGE TIMES	1	
VOLTAGE	U1	
RANGE	300 V	
VT(PT)	0001.00	
CURRENT	CH1	
RANGE	100 A	
CT	0001.00	
SENSOR	9661	
change	NEXT SCR	

Measurement setting screen

## 5.2.1 Setting the Wiring Method

SET UP 1/5 MEASUREMENT	2002/07/24 16:26:28
WIRING	1P2W ×1
SAMPLING	PLL 50Hz
VAR METHOD	OFF
AVERAGE TIMES	1
VOLTAGE	U1
RANGE	300 V
VT(PT)	0001.00
CURRENT	CH1
RANGE	100 A
CT	0001.00
SENSOR	9661
change	NEXT SCR

(3169-20: SET UP 1/4,  
3169-21: SET UP 1/5)

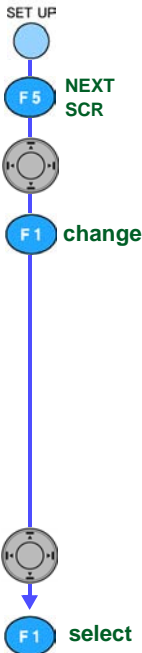

Press the **SET UP** key to display the setting screen.

Press the **F5** (NEXT SCR) key to display the measurement setting screen.

Move the cursor to "WIRING."

Press the **F1** (change) key to display the selection window.

1P2W	Measurement of a single-phase, 2-wire line
1P3W	Measurement of a single-phase, 3-wire line
3P3W2M	Measurement of a three-phase, 3-wire line (by the two-power-meter method) *: Select this method to measure three-phase power by measuring the current at two positions only.
3P3W3M	Measurement of a three-phase, 3-wire line (by the three-power-meter method)
3P4W	Measurement of a three-phase, 4-wire line
3P4W4I	Measurement of a three-phase, 4-wire line (used for neutral conductor measurement)

Select a wiring method by using the cursor key.

Press the **F1** (select) key.

### NOTE

#### 3P3W2M and 3P3W3M

The active power measurement results will be the same regardless of whether measurement is conducted by 3P3W2M (i.e., 2-voltage, 2-current, 2-power-meter method) or 3P3W3M (i.e., 3-voltage, 3-current, 3-power-meter method). When 3P3W2M is selected, U3 and I3 will be calculated based on the U1, U2, or I1, I2 measurements.

## Set the Number of Circuits to Be Measured.

SET UP 1/5 MEASUREMENT		2002/07/24 16:27:03
WIRING	1P2W	<input checked="" type="checkbox"/>
SAMPLING	PLL	50Hz
VAR METHOD	OFF	
AVERAGE TIMES	1	
VOLTAGE	U1	
RANGE	300 V	
VT(PT)	0001.00	
CURRENT	CH1	
RANGE	100 A	
CT	0001.00	
SENSOR	9661	
x1	x2	x3
x4	NEXT SCR	

(3169-20: SET UP 1/4,  
3169-21: SET UP 1/5)

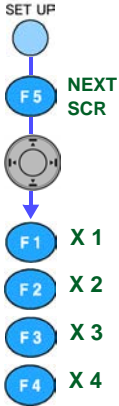

Press the **SET UP** key to display the setting screen.

Press the **F5** (NEXT SCR) key to display the measurement setting screen.

Move the cursor to Number of Circuits.

Set the number of circuits by using the function keys.

1P2W	X 1 (1 circuit), X 2 (2 circuits), X 3 (3 circuits), X 4 (4 circuits)
1P3W	X 1 (1 circuit), X 2 (2 circuits)
3P3W2M	X 1 (1 circuit), X 2 (2 circuits)
3P3W3M,3P4W, 3P4W4I	X 1 (1 circuit) only

The 3169-20/21 can measure multiple circuits of the same voltage system (same transformer).

## 5.2.2 Setting the Synchronization Method

SET UP 1/5 MEASUREMENT 2002/07/24  
16:27:14

WIRING 1P2W x1

SAMPLING **PLL** 50Hz

VAR METHOD OFF

AVERAGE TIMES 1

VOLTAGE U1

RANGE 300 V

VT(PT) 0001.00

CURRENT CH1

RANGE 100 A

CT 0001.00

SENSOR 9661

PLL FIXED NEXT SCR

(3169-20: SET UP 1/4,  
3169-21: SET UP 1/5)

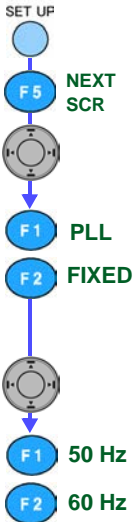

Press the **SET UP** key to display the setting screen.

Press the **F5** (NEXT SCR) key to display the measurement setting screen.

Move the cursor to "SAMPLING."

Set the synchronization method by using the function keys.

PLL	PLL (default)
FIXED	Fixed clock

\* Normally set to PLL

Move the cursor to Measured Frequency.

Set to the frequency of the line to be measured by using the function keys. (Default: 50 Hz)



### What is PLL?

PLL stands for "Phase Locked Loop" and is a phase synchronization circuit. The 3169-20/21 uses PLL to generate a frequency synchronized with the fundamental wave (50/60 Hz) and multiplied by 128, to sample input waveforms of voltage and current. If there is no PLL input (PLL source), there is no means of sampling input waveforms, and calculation cannot be performed. This is called "PLL unlock." When there is no PLL source, the 3169-20/21 switches the synchronization method over to the internal clock (50/60 Hz fixed clock).

### 5.2.3 Setting the Reactive-Power-Meter Method

SET UP 1/5 MEASUREMENT		2002/07/24 18:27:21
WIRING	1P2W	×1
SAMPLING	PT	50Hz
VAR METHOD	OFF	
AVERAGE TIMES	↓	
VOLTAGE	U1	
RANGE	300 V	
VT(PT)	0001.00	
CURRENT	CH1	
RANGE	100 A	
CT	0001.00	
SENSOR	9661	
OFF	ON	NEXT SCR

(3169-20: SET UP 1/4,  
3169-21: SET UP 1/5)

SET UP



F5



NEXT  
SCR



F1



OFF

F2



ON

Press the **SET UP** key to display the setting screen.

Press the **F5** (NEXT SCR) key to display the measurement setting screen.

Move the cursor to "**VAR METHOD.**"

Use the function keys to set whether to use the reactive-power-meter method.

OFF	Do not use the reactive-power meter method (default).
ON	Use the reactive-power-meter method.

#### NOTE

When the reactive-power-meter method is OFF (not to be used), the signs for lag and lead will not be added to reactive-power measurements.



◆ **What is the Reactive-power-meter method?**

- The reactive-power-meter method is used to measure reactive power directly from the voltage and current, like a reactive power meter installed for large power consumers.
- With some voltage and current waveforms, reactive power, apparent power, and power factor measurements may vary depending on the reactive-power-meter setting.
- <Influence on the Power Factor>

When the reactive-power-meter method is OFF (not to be used), the power factor is obtained as a ratio of the active power to apparent power. Because calculation includes the harmonic component, the power factor will decrease as the harmonic current increases.

When the reactive-power-meter method is ON (to be used), the power factor is obtained as a cosine of the phase difference between the fundamental voltage and fundamental current. Calculation is performed using the fundamental component only, and does not include the harmonic component.

## 5.2.4 Setting the Display Average Times

SET UP 1/5 MEASUREMENT		2002/07/24 16:27:25
WIRING	1P2W	×1
SAMPLING	PLL	50Hz
VAR METHOD	OFF	
AVERAGE TIMES	1	
VOLTAGE	U1	
RANGE	300 V	
VT(PT)	0001.00	
CURRENT	CHI	
RANGE	100 A	
CT	0001.00	
SENSOR	9661	
change		NEXT SCR

(3169-20: SET UP 1/4,  
3169-21: SET UP 1/5)

SET UP



Press the **SET UP** key to display the setting screen.



NEXT  
SCR

Press the **F5** (NEXT SCR) key to display the measurement setting screen.



Move the cursor to "**AVERAGE TIMES.**"



change

Press the **F1** (change) key to display the selection window.

1 (default), 2, 5, 10, 20 times



Select a display averaging times by using the cursor key.



select

Press the **F1** (select) key.

### NOTE

- The display averaging times is the number of moving averages calculated for instantaneous values (i.e., instantaneous measurements excluding harmonics).
- The moving average is obtained by totaling the set number of measurements and dividing the sum by the set number. After the set number of measurements have been acquired, the 3169-20/21 discards the oldest measurement data every time it acquires new measurement data, and continues to average the set number of measurements.

Value to be displayed on-screen =  $(Z_{(n - (N - 1))} + Z_{(n - (N - 2))} + \dots + Z_n) / N$

$Z_n$ : The nth measurement

N: Set number

If measurements fluctuate drastically, use the averaging function to stabilize the values displayed on-screen.

## 5.2.5 Setting the Voltage Range

SET UP 1/5 MEASUREMENT		2002/07/24 16:27:34
WIRING	1P2W	x1
SAMPLING	PLL	50Hz
VAR METHOD	OFF	
AVERAGE TIMES	1	
VOLTAGE	U1	
RANGE	300 V	
VT(PT)	0001.00	
CURRENT	CH1	
RANGE	100 A	
CT	0001.00	
SENSOR	9661	
-	+	NEXT SCR

(3169-20: SET UP 1/4,  
3169-21: SET UP 1/5)

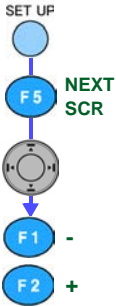

Press the **SET UP** key to display the setting screen.

Press the **F5** (NEXT SCR) key to display the measurement setting screen.

Move the cursor to "VOLTAGE RANGE."

Set the voltage range by using the function keys as follows:  
(Select a range from 150 V, 300 V, and 600 V.)

-	Changes to a smaller range.
+	Changes to a larger range.

### NOTE

A range can be selected using the **U RANGE** key on the measurement screen.

## 5.2.6 Setting the VT Ratio (PT Ratio)

SET UP 1/5 MEASUREMENT		2002/07/24 16:27:33
WIRING	1P2W	×1
SAMPLING	PLL	50Hz
VAR METHOD	OFF	
AVERAGE TIMES	1	
VOLTAGE	U1	
RANGE	300 V	
VT(PT)	0001.00	
CURRENT	CH1	
RANGE	100 A	
CT	0001.00	
SENSOR	9661	
-	+	NEXT SCR

(3169-20: SET UP 1/4,  
3169-21: SET UP 1/5)

SET UP



NEXT  
SCR



-



+

Press the **SET UP** key to display the setting screen.

Press the **F5** (NEXT SCR) key to display the measurement setting screen.

Move the cursor to the "VT" digit to be changed.

Set the VT ratio by using the function keys as follows:  
(Cursor ◀: Moves left to next digit; Cursor ▶: Moves right to next digit)

-	Decrements the number.
+	Increments the number.

Setting range: 0.01 to 9999.99 (Default: 1.00)

### NOTE

This ratio is used for measurement conducted on the secondary side of an external voltage transformer (VT) to convert the voltage measured to the primary voltage to be displayed.



### What is VT?

VT stands for "voltage transformer." It is also referred to as "PT" (potential transformer). VT is used in high-voltage measurement to convert (step-down) the voltage measured to a smaller level and supply the conversion result to an instrument.

VT ratio (voltage transformation ratio): A ratio used to convert the secondary voltage of VT to the primary voltage.

## 5.2.7 Setting the Current Range

SET UP 1/5 MEASUREMENT		2002/07/24 16:28:31		
WIRING	1P2W	×4		
SAMPLING	PLL	50Hz		
VAR METHOD	OFF			
AVERAGE TIMES	1			
VOLTAGE	U1			
RANGE	300 V			
VT(PT)	0001.00			
CURRENT	CH1	CH2	CH3	CH4
RANGE	100 A	100 A	100 A	100 A
CT	0001.00	0001.00	0001.00	0001.00
SENSOR	9661	9661	9661	9661
-	+	NEXT SCR		

(3169-20: SET UP 1/4,  
3169-21: SET UP 1/5)

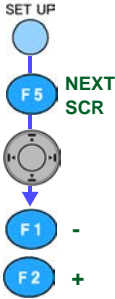

Press the **SET UP** key to display the setting screen.

Press the **F5** (NEXT SCR) key to display the measurement setting screen.

Move the cursor to "**CURRENT RANGE**" of the circuit to be changed.

Set the current range by using the function keys as follows:

-	Changes to a smaller range.
+	Changes to a larger range.

Clamp-On Sensor and Current Range

9660/9695-03	5 A, 10 A, 50 A, 100 A
9661	5 A, 10 A, 50 A, 100 A, 500 A
9667-5 kA (5000 A range)	5 kA
9667-500 A (500 A range)	500 A
9669	100 A, 200 A, 1 kA
9694	0.5 A, 1 A, 5 A
9695-02	0.5 A, 1 A, 5 A, 10 A, 50 A

### NOTE

The selectable current ranges vary depending on the clamp-on sensor used. When the connection method is 3P4W4I, a current range can be set for I4 that differs from that for I1 to I3.

## 5.2.8 Setting the CT Ratio

SET UP 1/5 MEASUREMENT		2002/07/24 16:28:35		
WIRING	1P2W	×4		
SAMPLING	PLL	50Hz		
VAR METHOD	OFF			
AVERAGE TIMES	1			
VOLTAGE	U1			
RANGE	300 V			
VT(PT)	0001.00			
CURRENT	CH1	CH2	CH3	CH4
RANGE	100 A	100 A	100 A	100 A
CT	0001.00	0001.00	0001.00	0001.00
SENSOR	9661	9661	9661	9661
-	+			NEXT SCR

(3169-20: SET UP 1/4,  
3169-21: SET UP 1/5)

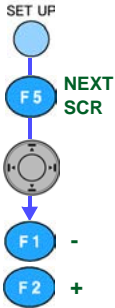

Press the **SET UP** key to display the setting screen.

Press the **F5 (NEXT SCR)** key to display the measurement setting screen.

Move the cursor to the digit of "**CT**" of the circuit to be changed.

Set the CT ratio for each circuit by using the function keys.  
(Cursor ◀: Moves left to next digit; Cursor ▶: Moves right to next digit)

-	Decrements the number.
+	Increments the number.

Setting range: 0.01 to 9999.99 (Default: 1.00)

### NOTE

This ratio is used for measurement on the secondary side of an external current transformer (CT) to convert the current measured to the primary current to be displayed.



### What is CT?

CT stands for "current transformer." CT is used to measure large current to reduce the current measured to a smaller level and supply the conversion result to an instrument.

CT ratio (current transformation ratio): A ratio used to convert the secondary current of CT to the primary current.

## 5.2.9 Setting the Clamp-On Sensor

SET UP 1/5 MEASUREMENT		2002/07/24 16:28:41		
WIRING	1P2W ×4			
SAMPLING	PLL 50Hz			
VAR METHOD	OFF			
AVERAGE TIMES	1			
VOLTAGE	U1			
RANGE	300 V			
VT(PT)	0001.00			
CURRENT	CH1	CH2	CH3	CH4
RANGE	100 A	100 A	100 A	100 A
CT	0001.00	0001.00	0001.00	0001.00
SENSOR	9661	9661	9661	9661
change				NEXT SCR

(3169-20: SET UP 1/4,  
3169-21: SET UP 1/5)

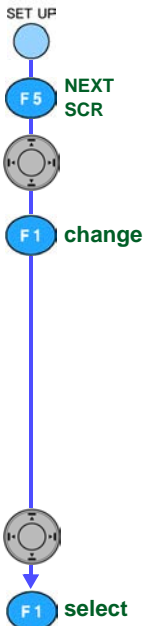

Press the **SET UP** key to display the setting screen.

Press the **F5** (NEXT SCR) key to display the measurement setting screen.

Move the cursor to "**SENSOR**" of the circuit to be changed.

Press the **F1** (change) key to display the selection window.

9660	Use the 9660 CLAMP ON SENSOR (100 A rated).
9661	Use the 9661 CLAMP ON SENSOR (500 A rated).
9667-5kA	Use the 9667/CT9667 FLEXIBLE CLAMP ON SENSOR (5000 A rated). (5000 A range)
9667-500A	Use the 9667/CT9667 FLEXIBLE CLAMP ON SENSOR (500 A rated). (500 A range)
9669	Use the 9669 CLAMP ON SENSOR (1000 A rated).
9694	Use the 9694 CLAMP ON SENSOR (5 A rated).
9695-02	Use the 9695-02 CLAMP ON SENSOR (50 A rated).
9695-03	Use the 9695-03 CLAMP ON SENSOR (100 A rated).

Select a clamp-on sensor for each circuit by using the cursor key.

Press the **F1** (select) key.

### NOTE

- When the wiring method is 3P4W4I, a clamp-on sensor can be set for I4 that differs from that for I1 to I3.
- When using the CT9667 sensor, choose "9667" for the clamp-on sensor.
- The range setting for the 9667 sensor is made on the sensor (500/5000 A range). When power to the 9667 is turned off, then back on again, the range is always set to 5000 A. When the 9667 is to be used for an extended period with the AC adapter, we recommend that a battery be used as well.

## 5.3 Setting on the Data Output Setting Screen (DATA OUTPUT)

The data output setting screen allows setting of the following items.

- Time-series measurement start method
- Time-series measurement ending method
- Interval
- Medium for saving data
- Data file name
- Device to be connected to RS-232C
- Medium to which the screen is to be copied

SET UP 2/5 DATA OUTPUT		2002/07/24
		19:15:25
MEAS. START	TIME	2002/07/24 19:30
MEAS. STOP	MANUAL	
INTERVAL TIME	30 min	
SAVE IN...	PC CARD	
DATA FILE NAME		
RS CONNECTION	PC	
DISPLAY COPY	PC CARD	
MANUAL	TIME	JUST NEXT SCR



### 5.3.1 Setting the Time-Series Measurement Start Method

SET UP 2/5 DATA OUTPUT	2002/07/24 19:15:25
MEAS. START	TIME
MEAS. STOP	MANUAL
INTERVAL TIME	30 min
SAVE IN...	PC CARD
DATA FILE NAME	
RS CONNECTION	PC
DISPLAY COPY	PC CARD
MANUAL TIME	JUST
	NEXT SCR

(3169-20: SET UP 2/4,  
3169-21: SET UP 2/5)

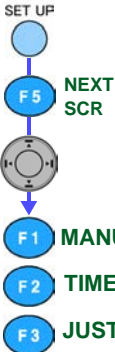

Press the **SET UP** key to display the setting screen.

Press the **F5** (NEXT SCR) key to display the data output setting screen.

Move the cursor to "**MEAS. START.**"

Set the time-series measurement start method using the function keys.

MANUAL	Manual Measurement starts when the <b>START/STOP</b> key is pressed (default setting).
TIME	Measurement starts at the set time.*1
JUST	Measurement will begin as soon as the internal clock reaches a time that is evenly divisible by the set interval.  Example: If the current time is 10:41:22, and the measurement interval is set to 30 minutes, then measurement will start at 11:00:00 (:00 minutes [or :60 minutes] is evenly divisible by 30 as $60/30 = 2$ with no remainder) with the next recording at 11:30:00, 12:00:00, etc.). If the interval is set to 10 minutes, measurement will start at 10:50:00.

\*1: The 3169-20/21 will enter into waiting status when the **START/STOP** key is pressed to start measurement. Measurement will then start at the set time.

#### NOTE

The **START/STOP** key is effective only when the measurement screen is displayed. It is not effective when the setting screen is displayed.

## Notes for long term measurement

The longest measurement period of this unit is one year. The instrument will automatically stop time-series measurement when one year has elapsed since the start of the time-series measurement. To continue measurement, restart the unit and then resume the time-series measurement.

- The measurement settings are saved even after restarting the unit.  
Set the time again when using the "TIME" start and stop.

## Set the Time-Series Measurement Start Time (when the start method is set to time).

SET UP 2/5 DATA OUTPUT	2002/07/24 19:15:42
MEAS. START	TIME
	2002/07/24 19:30
MEAS. STOP	MANUAL
INTERVAL TIME	30 min
SAVE IN...	PC CARD
DATA FILE NAME	
RS CONNECTION	PC
DISPLAY COPY	PC CARD
- +	AUTO NEXT SCR



Move the cursor to the digit to be changed in the measurement start date and time.

Set the start time using the function keys.

(Cursor ◀: Moves left to next digit; Cursor ▶: Moves right to next digit)

-	Decrements the number.
+	Increments the number.
AUTO	Set the start time to any subsequent time.

## NOTE

If the set measurement start time has already expired when the **START/STOP** key is pressed, the 3169-20/21 displays an error message and starts measurement by the "Just" start method, which commences measurement at the optimal time.

### 5.3.2 Setting Time-Series Measurement Stop Method

SET UP 2/5 DATA OUTPUT		2002/07/24 19:16:04	
MEAS. START	MANUAL		
MEAS. STOP	<b>MANUAL</b>		
INTERVAL TIME	30 min		
SAVE IN...	PC CARD		
DATA FILE NAME			
RS CONNECTION	PC		
DISPLAY COPY	PC CARD		
MANUAL	TIME	TIMER	NEXT SCR

(3169-20: SET UP 2/4,  
3169-21: SET UP 2/5)

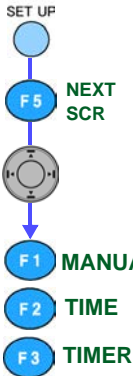

Press the **SET UP** key to display the setting screen.

Press the **F5** (NEXT SCR) key to display the data output setting screen.

Move the cursor to "**MEAS. STOP**."

Set the time-series measurement stop method using the function keys.

MANUAL	Manual Measurement stops when the <b>START/STOP</b> key is pressed (default setting).
TIME	Measurement stops at the exact time set by users.
TIMER	Measurement stops when the duration set by the users has elapsed. 1 second to 8784 hours

#### NOTE

When the stop method is set to Time or Timer, if the **START/STOP** key is pressed during measurement, a message is displayed requesting confirmation. Pressing the **F1** (yes) key stops measurement immediately.

## Set the Time-Series Measurement Stop Time (when the stop method is set to Time).

SET UP 2/5 DATA OUTPUT		2002/07/24 13:16:23
MEAS. START	MANUAL	
MEAS. STOP	TIME	
	2002/07/25 01:00	
INTERVAL TIME	30 min	
SAVE IN...	PC CARD	
DATA FILE NAME		
RS CONNECTION	PC	
DISPLAY COPY	PC CARD	
-	+	NEXT SCR



Move the cursor to the digit to be changed in the measurement stop date and time.

Set the measurement stop time using the function keys.

(Cursor ◀: Moves left to next digit; Cursor ▶: Moves right to next digit)

-	Decrements the number.
+	Increments the number.

## Set the Timer (when the stop method is set to Timer).

SET UP 2/5 DATA OUTPUT		2002-07-24 19:16:56
MEAS. START	MANUAL	
MEAS. STOP	TIMER	
	0000:01:00	
INTERVAL TIME	1 min	
SAVE IN...	PC CARD	
DATA FILE NAME		
RS CONNECTION	PC	
DISPLAY COPY	PC CARD	
-	+	NEXT SCR



Move the cursor to the digit of the timer setting to be changed.

Set the timer using the function keys.

(Cursor ◀: Moves left to next digit; Cursor ▶: Moves right to next digit)

-	Decrements the number.
+	Increments the number.

### 5.3.3 Setting Interval

SET UP 2/5 DATA OUTPUT		2002/07/24 19:17:10
MEAS. START	MANUAL	
MEAS. STOP	MANUAL	
INTERVAL TIME	<b>30 min</b>	
SAVE IN...	PC CARD	
DATA FILE NAME		
RS CONNECTION	PC	
DISPLAY COPY	PC CARD	
change		NEXT SCR

(3169-20: SET UP 2/4,  
3169-21: SET UP 2/5)

SET UP



Press the **SET UP** key to display the setting screen.

F5

NEXT  
SCR



Press the **F5** (NEXT SCR) key to display the data output setting screen.

Move the cursor to "**INTERVAL TIME.**"

F1

change



Press the **F1** (change) key to display the selection window.

Standard interval	1, 2, 5, 10, 15, 30 s, 1, 2, 5, 10, 15, 30, 60 m
Short-term interval	Full wave (Each one cycle), 100m, 200m, 500ms

Select an interval with the cursor key.

F1

select



Press the **F1** (select) key.

#### NOTE

- The data storable time varies depending on the setting of the data storage items and interval.
- The setting ranges for data output items vary depending on the setting of the interval.
- When the interval is 30 seconds or less, harmonic measurement-data output and printer output are not available.
- When a short-term interval is selected, the 3169-20/21 outputs the instantaneous values of normal measurement only. The file will be in binary format and must be converted to a text file to be read into a generally available spreadsheet software. For details on spreadsheet software, see the CD-R supplied with the 3169-20/21.

### 5.3 Setting on the Data Output Setting Screen (DATA OUTPUT)

#### NOTE

Observe the following precautions when setting the interval to 2 seconds or less:

- Use the optional PC card.
- Be sure to format the PC card.
- Insert the PC card before starting time-series measurement.
- Do not remove the PC card during measurement.
- Do not perform communications.
- Do not operate the keys too frequently.

#### 5.3.4 Setting Medium for Saving Data

SET UP 2/5 DATA OUTPUT		2002/07/24 18:17:18
MEAS. START	MANUAL	
MEAS. STOP	MANUAL	
INTERVAL TIME	30 min	
SAVE IN...	PC CARD	
DATA FILE NAME		
RS CONNECTION	PC	
DISPLAY COPY	PC CARD	
CARD	MEMORY	NEXT SCR

(3169-20: SET UP 2/4,  
3169-21: SET UP 2/5)

SET UP



F5 NEXT SCR



F1 CARD

F2 MEMORY

Press the **SET UP** key to display the setting screen.

Press the **F5** (NEXT SCR) key to display the data output setting screen.

Move the cursor to "SAVE IN...."

**F1** **CARD** Set the medium for saving data using the function keys.

#### NOTE

When the PC card is selected, if a PC card is not installed or the 3169-20/21 fails to write data onto the PC card, the data will be stored in the internal memory as backup data.

### 5.3.5 Setting the Data File Name

SET UP 2/5 DATA OUTPUT		2002/07/24 19:18:01
MEAS. START	MANUAL	
MEAS. STOP	MANUAL	
INTERVAL TIME	30 min	
SAVE IN...	PC CARD	
DATA FILE NAME	ABCDEFGH	
RS CONNECTION	PC	
DISPLAY COPY	PC CARD	
change	NEXT SCR	

(3169-20: SET UP 2/4,  
3169-21: SET UP 2/5)

SET UP



Press the **SET UP** key to display the setting screen.

F5

NEXT  
SCR

Press the **F5** (NEXT SCR) key to display the data output setting screen.



Move the cursor to "**DATA FILE NAME.**"

F1

change

Press the **F1** (Change) key to display the file-name input window.



Set the file name using the cursor and function keys (up to 8 letters and numbers).

F1

input

Cursor	Selects characters
input	Inputs the selected character
BS	Backspace (deletes the inputted character)
enter	Accepts the file name entry
cancel	Exits the file name input window unchanged

F2

BS

F3

enter

F4

cancel

#### NOTE

If no file name is set, the 3169-20/21 will automatically name the file.

❖ 7.1 Types of Files (page 119)



### 5.3.6 Setting Device to Be Connected to the RS-232C

SET UP 2/5 DATA OUTPUT		2002/07/24 19:18:53
MEAS. START	MANUAL	
MEAS. STOP	MANUAL	
INTERVAL TIME	30 min	
SAVE IN...	PC CARD	
DATA FILE NAME		
RS CONNECTION	PC	
DISPLAY COPY	PC CARD	
PC	PRINTER	NEXT SCR

(3169-20: SET UP 2/4,  
3169-21: SET UP 2/5)

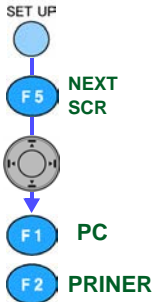

Press the **SET UP** key to display the setting screen.

Press the **F5** (NEXT SCR) key to display the data output setting screen.

Move the cursor to "RS CONNECTION."

Use the function keys to set the device to be connected to the RS-232C interface (Default: PC).

### 5.3.7 Setting the Medium to which the Screen is to be Copied

SET UP 2/5 DATA OUTPUT		2002/07/24 19:18:55
MEAS. START	MANUAL	
MEAS. STOP	MANUAL	
INTERVAL TIME	30 min	
SAVE IN...	PC CARD	
DATA FILE NAME		
RS CONNECTION	PC	
DISPLAY COPY	PC CARD	
CARD	MEMORY	NEXT SCR

(3169-20: SET UP 2/4,  
3169-21: SET UP 2/5)

SET UP



Press the **SET UP** key to display the setting screen.



**F5** NEXT  
SCR

Press the **F5** (NEXT SCR) key to display the data output setting screen.



Move the cursor to "**DISPLAY COPY.**"



**F1** CARD

Use the function keys to set the medium to which the screen is to be copied.



**F2** MEMORY



**F3** PRINTER

#### NOTE

The **F3** (Printer) key will not be displayed on the screen unless the printer is selected as the device to be connected to the RS-232C.

## 5.4 Setting on the Save/Print Items Setting Screen (SAVE, PRINT ITEMS)

The save/print items setting screen allows the following items to be set or displayed:

- Display the number of output data items and storable time.
- Set the normal measurement-data output items.
- Set the integrated power and demand measurement-data output.
- Set the harmonic measurement-data output items.

### 5.4.1 Checking the number of output data items and Storable Time

(3169-20: SET UP 3/4,  
3169-21: SET UP 3/5)

SET UP 3/5 SAVE, PRINT ITEMS		2003/05/13 13:24:03	
		NO. OF ITEMS 25	
NORM. MEAS.	ON	INST.	OFF
		AVE.	ON
HARMONIC	OFF	MAX.	OFF
		MIN.	OFF
INTEG. & DEM.		ON	
SAVE TIME AVAIL. 114d 4h 4m 0s			
OFF		ON	
NEXT SCR			

Displays the number of output data items. Make sure the number of output data items does not exceed 256 when reading stored data into a generally available spreadsheet.

Save/print items setting screen

Displays the storable time

Displays the data storable time of the set medium for saving data (PC card/internal memory)

(xxx days: xx hours: xx minutes: xx seconds)

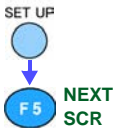

Press the **SET UP** key to display the setting screen.

Press the **F5** (NEXT SCR) key to display the save/print items setting screen.

## 5.4.2 Setting Normal Measurement-Data Output Items

SET UP 3/5 SAVE, PRINT ITEMS		2003/05/13 15:24:05	
NO. OF ITEMS			25
NORM. MEAS.	<b>ON</b>	INST.	OFF
		AVE.	ON
HARMONIC	OFF	MAX.	OFF
		MIN.	OFF
INTEG. & DEM.		ON	
SAVE TIME AVAIL. 114d 4h 4m 0s			
OFF	ON	NEXT SCR	

(3169-20: SET UP 3/4,  
3169-21: SET UP 3/5)

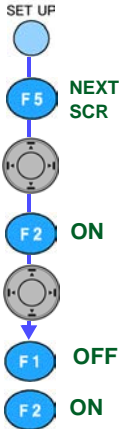

Press the **SET UP** key to display the setting screen.

Press the **F5** (NEXT SCR) key to display the save/print items setting screen.

Move the cursor to "**NORM. MEAS.**"

Press the **F2** (ON) key to turn ON normal measurement.

Move the cursor to "**INST.**"(instantaneous values.)

Turn data output ON/OFF using the function keys.

Turn the output of other items (average, maximum, and minimum values) ON/OFF in a similar way.

### NOTE

- Normal measurement data includes, for each channel, the voltage, current, active power, reactive power, apparent power, power factor, frequency, and each phase power.
- Detailed setting is not available for each piece of normal measurement data above.

### 5.4.3 Setting Integrated power and Demand Measurement-data Output Items

SET UP 3/5 SAVE, PRINT ITEMS				2003-05-13
				15:24:33
NO. OF ITEMS				25
NORM. MEAS.	ON	INST.	OFF	
		AVE.	ON	
HARMONIC	OFF	MAX.	OFF	
		MIN.	OFF	
INTEG. & DEM.				<b>ON</b>
SAVE TIME AVAIL.		114d 4h 4m 0s		
OFF	ON			NEXT SCR

(3169-20: SET UP 3/4,  
3169-21: SET UP 3/5)

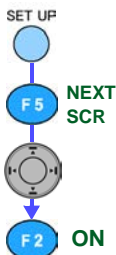

Press the **SET UP** key to display the setting screen.

Press the **F5** (NEXT SCR) key to display the save/print items setting screen.

Move the cursor to "INTEG. & DEM.."

Press the **F2** (ON) key to turn ON the integrated power/demand measurement data.

#### NOTE

- Integrated power/demand measurement data includes the total integrated power, integrated power within interval, demand value, and maximum demand value.
- Detailed setting cannot be performed for each piece of integrated power/demand measurement data above.

## 5.4.4 Setting Harmonic Measurement-data Output Items

### (1) Set the Harmonic Measurement-data Output.

SET UP 3/5 SAVE, PRINT ITEMS		2003/05/13 15:24:54	
		NO. OF ITEMS 48	
NORM. MEAS.	ON	INST.	OFF
		AVE.	ON
HARMONIC	<b>ON</b>	MAX.	OFF
		MIN.	OFF
INTEG. & DEM.		ON	
SAVE TIME AVAIL. 59d 10h 31m 0s			
OFF	ON	DETAILS	NEXT SCR

(3169-20: SET UP 3/4,  
3169-21: SET UP 3/5)

SET UP



Press the **SET UP** key to display the setting screen.



**NEXT  
SCR**

Press the **F5** (NEXT SCR) key to display the save/print items setting screen.



Move the cursor to "**HARMONIC**."



**ON**

Press the **F2** (ON) key to turn ON harmonic measurement.



Move the cursor to "**INST.**"(instantaneous values.)



**OFF**

Turn data output ON/OFF using the function keys.



**ON**

Turn the output of other items (average, maximum, and minimum values) ON/OFF in a similar way.

## (2) Set the Details of Harmonic Measurement-data Output.

SET UP 3/5 SAVE, PRINT ITEMS		2003/05/13	
Detailed settings		NO. OF ITEMS 67	
CIRCUIT	ON		
CH	U1 ON U2 OFF U3 OFF	P ON	
	I1 ON I2 OFF I3 OFF	I4 OFF	
TYPE	LEVEL ON	%ofFND OFF	PHASE OFF
	THD ON	TOTAL OFF	WAVE OFF
ORDER	SELECT		
	*01 02 *03 04 *05 06 *07 08 *09 10		
	*11 12 *13 14 15 16 17 18 19 20		
	21 22 *23 24 25 26 27 28 29 30		
	31 32 *33 34 35 36 37 38 39 40		
SAVE TIME AVAIL.	42d 13h 46m 0s		
OFF	ON	RETURN	

**DETAILS**

Press the **F3** (Detail Setting) key on the save/print items setting screen to display the harmonic output detail setting screen.



Turn the output of each piece of data ON/OFF using the cursor and function keys.

**OFF****ON****NOTE**

- The waveform data is not printed in the auto print function.
- The waveform data of U3 and I3 are not saved in the 3P3W2M wiring system.

## Select Order for Output.

SET UP 3/5 SAVE, PRINT ITEMS					2003.05.13
Detailed settings					NO. OF ITEMS 67
CIRCUIT	1 ON				
CH	U1 ON	U2 OFF	U3 OFF	P ON	
	I1 ON	I2 OFF	I3 OFF	I4 OFF	
TYPE	LEVEL ON	%ofFND OFF	PHASE OFF		
	THD ON	TOTAL OFF	WAVE OFF		
ORDER	<b>SELECT</b>				
	*01	02	*03	04	*05
	*11	12	*13	14	*15
	21	22	23	24	25
	31	32	33	34	35
	36	37	38	39	40
SAVE TIME AVAIL.	42d 13h 46m 0s				
ALL	ODD	EVEN	SELECT	RETURN	



Move the cursor to "**ORDER.**"



**ALL**

Set orders using the function keys.



**ODD**



**EVEN**



**SELECT**

When **F4** (SELECT) is selected



Move the cursor to the order of the data to be output.



**OFF**

Turn data output ON/OFF using function keys.

(When an asterisk "\*" marks the order, the data will be output.)



**ON**



## 5.5 Setting on the System Setting Screen

The system setting screen allows setting of the following items:

- Total harmonic distortion (THD) calculation method
- Harmonic order for display
- RS-232C
- LCD backlight
- Beep sound
- ID No.
- Clock
- Language
- Display of the Version/serial No.

SET UP 4/5 SYSTEM		2002/07/24 19:23:55
THD	THD-F	
HARM. DISP. ORD.	ALL ORDERS	
RS-232C		
BAUD RATE	9600bps	
TERMINATOR	CR+LF	
FLOW CONTROL	NONE	
BACKLIGHT	AUTO	
BEEP SOUND	ON	
ID	001	
TIME AND DATE	2002/07/24 19:22:56	
LANGUAGE	ENGLISH	
SERIAL NUMBER	020437412 Ver. 1.02	
THD-F	THD-R	NEXT SCR

## 5.5.1 Setting the THD Calculation Method

SET UP 4/5 SYSTEM		2002/07/24 19:23:55
THD	<b>THD-F</b>	
HARM. DISP. ORD.	ALL ORDERS	
RS-232C		
BAUD RATE	9600bps	
TERMINATOR	CR+LF	
FLOW CONTROL	NONE	
BACKLIGHT	AUTO	
BEEP SOUND	ON	
ID	001	
TIME AND DATE	2002/07/24 19:22:56	
LANGUAGE	ENGLISH	
SERIAL NUMBER	020437412 Ver. 1.02	
THD-F	THD-R	NEXT SCR

(3169-20: SET UP 4/4,  
3169-21: SET UP 4/5)

SET UP



Press the **SET UP** key to display the setting screen.

F5

NEXT  
SCR



Press the **F5** (NEXT SCR) key to display the system setting screen.



Move the cursor to "**THD.**"



THD-F

Set the THD calculation method using the function keys.

F1

F2

THD-R

THD-F	Total Harmonic Distortion (Fundamental reference) Ratio of the harmonic to the fundamental (default)
THD-R	Total Harmonic Distortion (RMS reference) Ratio of the harmonic to the total harmonic RMS values, including fundamental and all other harmonics

### NOTE

The selected THD calculation method will be used for both the harmonic voltage and harmonic current.

## 5.5.2 Setting the Harmonic Order for Display

SET UP 4/5 SYSTEM		2002/07/24 19:24:09
THD	THD F	
HARM. DISP. ORD.	<b>ALL ORDERS</b>	
RS-232C		
BAUD RATE	9600bps	
TERMINATOR	CR+LF	
FLOW CONTROL	NONE	
BACKLIGHT	AUTO	
BEEP SOUND	ON	
ID	001	
TIME AND DATE	2002/07/24 19:22:56	
LANGUAGE	ENGLISH	
SERIAL NUMBER	020437412 Ver. 1.02	
ALL ORD	ODD	NEXT SCR

(3169-20: SET UP 4/4,  
3169-21: SET UP 4/5)

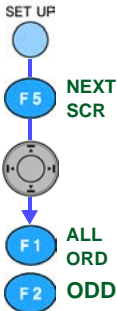

Press the **SET UP** key to display the setting screen.

Press the **F5** (NEXT SCR) key to display the system setting screen.

Move the cursor to "**HARM. DISP. ORD.**"

Use the function keys to set the harmonic orders to be displayed on the harmonic graph screen and harmonic list screen.

### 5.5.3 Setting the RS-232C

SET UP 4/5 SYSTEM		2002/07/24 19:24:16
THD	THD-F	
HARM. DISP. ORD.	ALL ORDERS	
RS-232C		
BAUD RATE	9600bps	
TERMINATOR	CR+LF	
FLOW CONTROL	NONE	
BACKLIGHT	AUTO	
BEEP SOUND	ON	
ID	001	
TIME AND DATE	2002/07/24 19:22:56	
LANGUAGE	ENGLISH	
SERIAL NUMBER	020437412 Ver. 1.02	
change	NEXT SCR	

(3169-20: SET UP 4/4,  
3169-21: SET UP 4/5)

SET UP



Press the **SET UP** key to display the setting screen.



**F5** NEXT  
SCR

Press the **F5** (NEXT SCR) key to display the system setting screen.



Move the cursor to "**BAUD RATE.**"



**F1** change

Press the **F1** (change) key to display the selection window.

2400 bps, 9600 bps, 19200 bps, 38400 bps



Select a baud rate using the cursor keys.



**F1** select

Press the **F1** (select) key.



Move the cursor to the "**TERMINATOR.**"



**F1** CR+LF

Set the end-of-line code using the function keys.



**F2** CR



Move the cursor to "**FLOW CONTROL.**"

Set the flow control using the function keys.



**F1** NONE



**F2** XON/XOFF



**F3** RTS/CTS



**F4** BOTH

## 5.5.4 Setting the LCD Backlight

SET UP 4/5 SYSTEM		2002/07/24 19:24:23	
THD	THD-F		
HARM. DISP. ORD.	ALL ORDERS		
RS-232C			
BAUD RATE	9600bps		
TERMINATOR	CR+LF		
FLOW CONTROL	NONE		
BACKLIGHT	<b>AUTO</b>		
BEEP SOUND	ON		
ID	001		
TIME AND DATE	2002/07/24 19:22:56		
LANGUAGE	ENGLISH		
SERIAL NUMBER	020437412 Ver. 1.02		
OFF	ON	AUTO	NEXT SCR

(3169-20: SET UP 4/4,  
3169-21: SET UP 4/5)

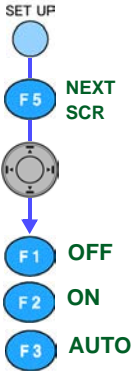

Press the **SET UP** key to display the setting screen.

Press the **F5** (NEXT SCR) key to display the system setting screen.

Move the cursor to "**BACKLIGHT.**"

Set the LCD backlight using the function keys.

OFF	The backlight remains OFF.
ON	The backlight remains ON.
AUTO	The backlight is automatically turned OFF 5 minutes after the last key operation (Default).

### NOTE

The life of the backlight is approximately 50,000 hours.

## 5.5.5 Setting the Beep Sound

SET UP 4/5 SYSTEM		2002/07/24 19:24:28
THD	THD-F	
HARM. DISP. ORD.	ALL ORDERS	
RS-232C		
BAUD RATE	9600bps	
TERMINATOR	CR+LF	
FLOW CONTROL	NONE	
BACKLIGHT	AUTO	
BEEP SOUND	<b>ON</b>	
ID	001	
TIME AND DATE	2002/07/24 19:22:56	
LANGUAGE	ENGLISH	
SERIAL NUMBER	020437412 Ver. 1.02	
OFF	ON	NEXT SCR

(3169-20: SET UP 4/4,  
3169-21: SET UP 4/5)

SET UP



NEXT  
SCR



OFF



ON

Press the **SET UP** key to display the setting screen.

Press the **F5** (NEXT SCR) key to display the system setting screen.

Move the cursor to "**BEEP SOUND.**"

Set the beep sound using the function keys.

OFF	The beep sound is not used.
ON	The beep sound is used (Default).

## 5.5.6 Setting the ID No.

SET UP 4/5 SYSTEM		2002/07/24 19:24:33
THD	THD-F	
HARM. DISP. ORD.	ALL ORDERS	
RS-232C		
BAUD RATE	9600bps	
TERMINATOR	CR+LF	
FLOW CONTROL	NONE	
BACKLIGHT	AUTO	
BEEP SOUND	ON	
ID	001	
TIME AND DATE	2002/07/24 19:22:56	
LANGUAGE	ENGLISH	
SERIAL NUMBER	020437412	Ver. 1.02
-	+	NEXT SCR

(3169-20: SET UP 4/4,  
3169-21: SET UP 4/5)

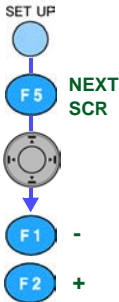

Press the **SET UP** key to display the setting screen.

Press the **F5 (NEXT SCR)** key to display the system setting screen.

Move the cursor to "ID."

(Cursor ◀: Moves left to next digit; Cursor ▶: Moves right to next digit)

-	Decrements the number.
+	Increments the number.

Setting range: 001 to 999 (Default: 001)

### NOTE

Set a number for the 3169-20/21 to identify the instrument. This ID No. is included in the setting data at the head of the stored data. The No. does not have to be set, if not necessary.

## 5.5.7 Setting the Clock

SET UP 4/5 SYSTEM		2002/07/24 19:24:36
THD	THD-F	
HARM. DISP. ORD.	ALL ORDERS	
RS-232C		
BAUD RATE	9600bps	
TERMINATOR	CR+LF	
FLOW CONTROL	NONE	
BACKLIGHT	AUTO	
BEEP SOUND	ON	
ID	001	
TIME AND DATE	2002/07/24 19:22:56	
LANGUAGE	ENGLISH	
SERIAL NUMBER	020437412 Ver. 1.02	
-	+	UPDATE NEXT SCR

(3169-20: SET UP 4/4,  
3169-21: SET UP 4/5)

SET UP



Press the **SET UP** key to display the setting screen.

F5

NEXT  
SCR

Press the **F5** (NEXT SCR) key to display the system setting screen.



Move the cursor to "**TIME AND DATE.**"

F1

-

Set the date and time using the function keys.

F2

+

-	Decrements the number.
+	Increments the number.

F3

UPDATE

Press the **F3** (UPDATE) key.

### NOTE

Set the clock using the time signal or other similar device before starting measurement.



## 5.5.8 Setting the Language

SET UP 4/5 SYSTEM		2002/07/24 19:24:43
THD	THD-F	
HARM. DISP. ORD.	ALL ORDERS	
RS-232C		
BAUD RATE	9600bps	
TERMINATOR	CR+LF	
FLOW CONTROL	NONE	
BACKLIGHT	AUTO	
BEEP SOUND	ON	
ID	001	
TIME AND DATE	2002/07/24 19:22:56	
LANGUAGE	ENGLISH	
SERIAL NUMBER	020457412 Ver. 1.02	
JAPANESE ENGLISH	NEXT SCR	

(3169-20: SET UP 4/4,  
3169-21: SET UP 4/5)

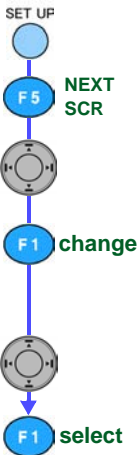

Press the **SET UP** key to display the setting screen.

Press the **F5** (NEXT SCR) key to display the system setting screen.

Move the cursor to "**LANGUAGE.**"

Press the **F1** (change) key to display the selection window.

JAPANESE, ENGLISH, DEUTSCH (GERMAN), ITALIANO (ITALIAN),  
CHINESE SIMPLE, CHINESE TRAD, FRANCAIS (FRENCH),  
ESPAÑOL (SPANISH), KOREAN

Set the language for display using the cursor keys.

Press the **F1** (select) key.

## 5.5.9 Displaying the Serial No. and Version

```

SET UP 4/5 SYSTEM                                2002/07/24
                                                19:23:55
THD                                               THD-F
HARM. DISP. ORD.  ALL ORDERS
RS-232C
  BAUD RATE      9600bps
  TERMINATOR     CR+LF
  FLOW CONTROL   NONE
BACKLIGHT       AUTO
BEEP SOUND      ON
ID              001
TIME AND DATE   2002/07/24 19:22:56
LANGUAGE        ENGLISH
SERIAL NUMBER   02043741/ Ver. 1.02
THD-F          THD-R                                NEXT SCR
  
```

(3169-20: SET UP 4/4,  
3169-21: SET UP 4/5)

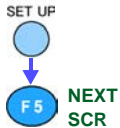

Press the **SET UP** key to display the setting screen.

Press the **F5** (NEXT SCR) key to display the system setting screen.

The serial No. and version will appear at "**SERIAL NUMBER.**"

# Measurement Method

# 6

Please read the Usage Notes (page 7) and Connecting to Lines to be Measured (page 37) before making connections.

## 6.1 Measuring the Voltage, Current, and Power (Instantaneous Values)

MAIN	<b>INST.</b>	CIRCUIT1	2002/06/13 00:06:59
U1	208.00 V	I1	4.9935 A
U2	207.97 V	I2	4.9958 A
U3*	207.80 V	I3*	4.9940 A
Uave	207.93 V	Iave	4.9944 A
P	1.5610kW	Q	0.8937kvar
		S	1.7987kVA
		PF	0.8678
		f	49.998 Hz
WP+	0.00000kWh		0:00:00
SCREEN CIRCUIT AVERAGE			HOLD

Indicates the item currently displayed



Switches over to the screen for the data of another circuit (when multiple circuits are measured)

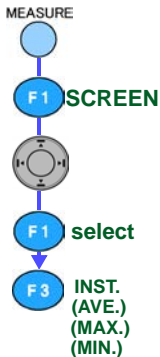

Press the **MEASURE** key to display the measurement screen.

Press the **F1** (SCREEN) key to display the selection window.

Select "**MAIN**" using the cursor key.

Press the **F1** (select) key to display the main screen.

Every time the **F3** key is pressed, the item to be displayed changes as follows:

"INST." → "AVE." → "MAX." → "MIN."



**NOTE**

- When 3P3W2M is selected as the wiring method, U3 and I3 are obtained by vector calculation. See the Appendix (page 203).
- When 3P3W3M is selected, P1, P2, and P3 are data for reference purposes only.
- When 3P4W or 3P4W4I is selected, the voltage is obtained as the phase to neutral voltage.
- When multiple circuits are measured, use the **F2** (CIRCUIT) key to display the data of other circuits.

## 6.2 Measuring the Power of Each Phase (Instantaneous values)

POWER	INST.	CIRCUIT1	2002.06.13 00:11:43
P1	0.8655kW	Q1	0.4963kvar
P2	0.8684kW	Q2	0.4949kvar
P3	0.8673kW	Q3	0.4964kvar
P	2.6013kW	Q	1.4876kvar
S1	0.9977kVA	PF1	0.8675
S2	0.9995kVA	PF2	0.8688
S3	0.9994kVA	PF3	0.8679
S	2.9966kVA	PF	0.8681

WIRING 3P4W  
CIRCUIT x1  
PLL U1 50Hz  
INTVL. 1min

SCREEN AVERAGE HOLD

Indicates the item currently displayed

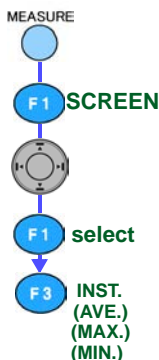

Press the **MEASURE** key to display the measurement screen.

Press the **F1** (SCREEN) key to display the selection window.

Select "**POWER**" using the cursor key.

Press the **F1** (select) key to display the power display screen of each channel.

Every time the **F3** key is pressed, the item to be displayed changes as follows:

"INST." → "AVE." → "MAX." → "MIN."



### NOTE

- When 3P3W2M is selected, the active power (P1, P2), reactive power (Q1, Q2), apparent power (S1, S2), and power factor (PF1, PF2) of each channel are meaningless data. Use the total values of P, Q, S, and PF only. The data of each channel is used as reference data for checking the wiring.
- When 3P3W3M is selected, the active power (P1, P2, P3), reactive power (Q1, Q2, Q3), and apparent power (S1, S2, S3) of each channel are data for reference purposes only.
- When the reactive-power-meter method is OFF, the reactive power (Q1, Q2, Q3) and apparent power (S1, S2, S3) of each channel are obtained by calculation using the line to line voltage.
- When multiple circuits are measured, use the **F2** (CIRCUIT) key to display the data of other circuits.

## 6.3 Displaying a Waveform

Display the voltage and current waveforms of a selected channel.

MEASURE



Press the **MEASURE** key to display the measurement screen.



**SCREEN**

Press the **F1** (SCREEN) key to display the selection window.



Select "**WAVEFORM**" using the cursor key.



**select**

Press the **F1** (select) key to display the waveform display screen.

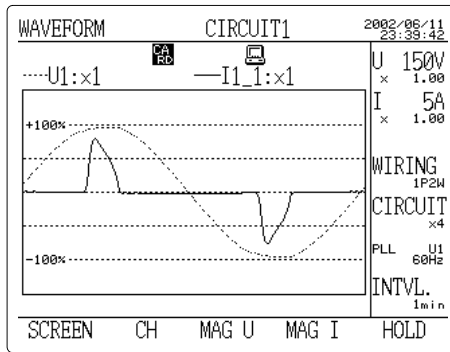

### NOTE

- The voltage waveform in the 3P3W3M wiring system is the phase voltage waveform referring to a virtual neutral point.
- The waveform of U3 and I3 is not displayed on the screen in the 3P3W2M is set as the wiring method.

## (1) Change the Channel to be Displayed.

**F2 CH** Every time the **F2** (CH) key is pressed, the channel to be displayed is changed as follows.

1P2W	U1, I1 → U1, I1 → U1, I1 → U1, I1 Circuit1 Circuit2 Circuit3 Circuit4 ↑
1P3W	U1, I1 → U2, I2 → U1, I1 → U2, I2 Circuit1 Circuit1 Circuit2 Circuit2 ↑
3P3W2M	U1, I1 → U2, I2 → U1, I1 → U2, I2 Circuit1 Circuit1 Circuit2 Circuit2 ↑
3P3W3M	U1, I1 → U2, I2 → U3, I3 ↑
3P4W	U1, I1 → U2, I2 → U3, I3 ↑
3P4W4I	U1, I1 → U2, I2 → U3, I3 → I4 ↑

## (2) Change the Voltage Y-Axis Magnification.

**F3 MAG U** Every time the **F3** (MAG U) key is pressed, the voltage y-axis magnification is changed as follows:  
X1/2 → X1 → X2 → X5 → X10  
↑

## (3) Change the Current Y-Axis Magnification.

**F4 MAG I** Every time the **F4** (MAG I) key is pressed, the current y-axis magnification is changed as follows:  
X1/2 → X1 → X2 → X5 → X10  
↑

## 6.4 Measuring the Average, Maximum, and Minimum Values

Measures the average, maximum, and minimum values of the voltage, current, power, and harmonic

Set the parameters on the measurement setting, data output setting, and save/print items setting screens.

❖ 5 Setting Procedure (page 59)

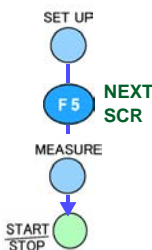

Press the **MEASURE** key to display the measurement screen.

Press the **START/STOP** key to start measurement. When the time-series measurement has started, the LED lights up, indicating that the 3169-20/21 is performing measurement. When the measurement start method is set to "Time" or "Just", the 3169-20/21 will stand by until the start time (the LED blinks) and start measurement at the start time.

### Ending of Time-Series Measurement



The time-series measurement stops by the method set on the data-output setting screen. Press the **START/STOP** key to stop the measurement when the stopping method is set to manual, or stop it immediately in any other mode.

#### NOTE

- If time-series measurement has been started by pressing the **START/STOP** key, the average, maximum, and minimum values will be displayed on the screen.
- The display shows the average, maximum, and minimum values of the measurements taken up to the current time from the start of time-series measurement.
- The pieces of data to be stored or printed out are the average, maximum, and minimum values of every interval.
- The average, maximum, and minimum values are not displayed for harmonic measurements.



### 6.4.1 Displaying the Voltage, Current, and Power (Average, Maximum, and Minimum Values)

MAIN		INST. <b>CIRCUIT1</b>		2002-05-13 00:06:59	
U1	208.00 V	I1	4.9935 A	U	300V × 1.00
U2	207.97 V	I2	4.9958 A	I	5A
U3*	207.80 V	I3*	4.9940 A	×	1.00
Uave	207.93 V	Iave	4.9944 A		
P	1.5610kW	Q	0.8937kvar	WIRING	
		S	1.7987kVA	3P3W2M	
		PF	0.8678	CIRCUIT	x2
		f	49.998 Hz	PLL	U1 50Hz
WP+	0.00000kWh		0:00:00	INTVL.	1min
SCREEN			CIRCUIT AVERAGE		HOLD

Indicates the item currently displayed

**F2** ← Changes the circuit to display (when multiple circuits are measured).

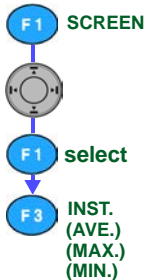

Press the **F1** (SCREEN) key on the measurement screen to display the selection window.  
Select **"MAIN"** using the cursor key.

Press the **F1** (select) key to display the main screen.

Every time the **F3** key is pressed, the item to be displayed is changed as follows:

**"INST." → "AVE." → "MAX." → "MIN."**

↑

#### NOTE

When multiple circuits are measured, use the **F2** (CIRCUIT) key to display the data of other circuits.

## 6.4.2 Displaying the Average, Maximum, and Minimum Power Measurements of Each Phase

POWER		INST.	CIRCUIT1	2002.06.13 00:11:43
P1	0.8655kW	Q1	0.4963kvar	U 300V × 1.00
P2	0.8684kW	Q2	0.4949kvar	I 5A
P3	0.8673kW	Q3	0.4964kvar	× 1.00
P	2.6013kW	Q	1.4876kvar	
S1	0.9977kVA	PF1	0.8675	WIRING 3P4W
S2	0.9995kVA	PF2	0.8688	CIRCUIT ×1
S3	0.9994kVA	PF3	0.8679	PLL U1 50Hz
S	2.9966kVA	PF	0.8681	INTVL. 1min
SCREEN		AVERAGE		HOLD

Indicates the item currently displayed

**F1** SCREEN

Press the **F1** (SCREEN) key on the measurement screen to display the selection window.  
Select **POWER** using the cursor key.



**F1** select

Press the **F1** (select) key to show the power display screen of each channel.

**F3**  
INST.  
(AVE.)  
(MAX.)  
(MIN.)

Every time the **F3** key is pressed, the item to be displayed is changed as follows:

"INST." → "AVE." → "MAX." → "MIN."



### NOTE

When multiple circuits are measured, use the **F2** (CIRCUIT) key to display the data of other circuits.

❖ 6.2 Measuring the Power of Each Phase (Instantaneous values) (page 101)

## 6.5 Measuring Integrated power

Measures integrated power (Wh)

INTEG.	CIRCUIT1	VAR	2002/06/13 00:17:38
RUNNING	OFF	ON	U 300V × 1.00
ACTIVE POWER	WP+	0.07360kWh	I 5A × 1.00
CONSUMP.	WP-	-0.00000kWh	WIRING 3P3W2M
REGEN.	WQ+	0.05421kvarh	CIRCUIT x2
REACTIVE POWER	WQ-	-0.00000kvarh	PLL 50Hz
LAG			INTVL. 1min
LEAD			
START TIME	2002/06/13	00:15:00	
STOP TIME	2002/07/13	00:00:00	
ELAPSED TIME		0:02:32	
SCREEN	CIRCUIT		HOLD

**F2** ← Changes the circuit to display  
(when multiple circuits are measured).

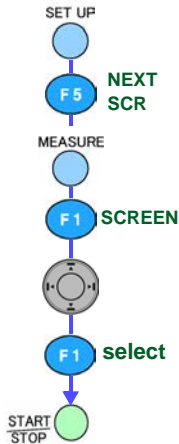

Set the measurement start/stop methods, interval, medium for saving data, and data output items on the measurement setting, data-output setting, and save/print items setting screens.

❖ Setting Procedure (page 59)

Press the **MEASURE** key to display the measurement screen.

**F1** SCREEN Press the **F1** (SCREEN) key to display the selection window.

Select "**INTEGRATE**" using the cursor key.

Press the **F1** (select) key to show the integrated power display screen.

Press the **START/STOP** key to start integrated power measurement.

### NOTE

- The display shows the total integrated power from the start of time-series measurement.
- When the reactive-power-meter method is OFF, the display does not show the lead (WQ-) values of the integrated reactive power.
- When multiple circuits are measured, use the **F2** (CIRCUIT) key to display data of other circuits.

## 6.6 Performing Demand Measurement

Performs demand measurement, which repeats integration measurement at every demand interval.

DEMAND		CIRCUIT1	VAR	2002/06/13 00:17:58
RUNNING				
PREVIOUS VALUE	LATEST VALUE		U	300V
P 1.7339kW	WP+ 0.01581kWh		×	1.00
Q 1.2769kvar	WP- -0.00000kWh		I	5A
PF 0.8052	WQ+ 0.01164kvarh		×	1.00
	WQ- -0.00000kvarh			
MAX DEMAND			WIRING	
P 1.7339kW	2002/06/13 00:16:00		3P3W2M	
START TIME	2002/06/13 00:17:00		CIRCUIT	
STOP TIME	2002/06/13 00:18:00		×	2
ELAPSED TIME	0:00:32		PLL	U1 50Hz
			INTVL.	1min
SCREEN	CIRCUIT			HOLD

 **F2** ← Changes the circuit to display  
(when multiple circuits are measured).

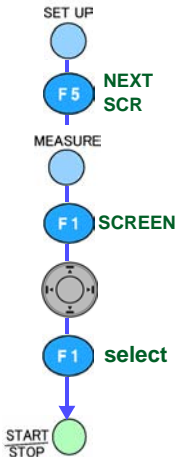

Set the measurement start/stop methods, interval, medium for saving data, and data output items on the measurement setting, data-output setting, and save/print items setting screens.  
 ❖ 5 Setting Procedure (page 59)

Press the **MEASURE** key to display the measurement screen.

Press the **F1** (SCREEN) key to display the selection window.

Select "**DEMAND**" using the cursor key.

Press the **F1** (select) key to show the demand display screen.

Press the **START/STOP** key to start demand measurement.

### NOTE

- The display shows the demand at every interval (previous value), the integrated power within each interval (latest value), the maximum demand from the start of time-series measurement, and the time of occurrence.
- When the reactive-power-meter method is OFF, the display does not show the lead (WQ-) values of the integrated reactive power.
- When multiple circuits are measured, use the **F2** (CIRCUIT) key to display data of other circuits.



6.7 Measuring Harmonic

Harmonic level	Level of each order of harmonic
Harmonic content	Content of each order of harmonic as a percentage of the fundamental
Harmonic-voltage (current) phase angle	Phase angle of each order of harmonic with respect to the phase of the fundamental component of $U_1$
Harmonic-power phase angle	Power factor of each order of harmonic expressed as an angle

Harmonic-Voltage-Level List Screen

U1	[V]	[%]	[deg]
1	104.72	100.00	-15.00
2	0.17	0.16	150.00
3	0.10	0.09	150.00
4	0.07	0.07	150.00
5	0.05	0.05	150.00
6	0.04	0.04	150.00
7	0.03	0.03	150.00
8	0.03	0.03	150.00
9	0.02	0.02	150.00
10	0.02	0.02	150.00
11	0.01	0.01	150.00
12	0.01	0.01	150.00
13	0.01	0.01	150.00
14	0.01	0.01	150.00
15	0.01	0.01	150.00
16	0.01	0.01	150.00
17	0.01	0.01	150.00
18	0.01	0.01	150.00
19	0.01	0.01	150.00
20	0.01	0.01	150.00
21	0.01	0.01	150.00
22	0.01	0.01	150.00
23	0.01	0.01	150.00
24	0.01	0.01	150.00
25	0.01	0.01	150.00
26	0.01	0.01	150.00
27	0.01	0.01	150.00
28	0.01	0.01	150.00
29	0.01	0.01	150.00
30	0.01	0.01	150.00
31	0.01	0.01	150.00
32	0.01	0.01	150.00
33	0.01	0.01	150.00
34	0.01	0.01	150.00
35	0.01	0.01	150.00
36	0.01	0.01	150.00
37	0.01	0.01	150.00
38	0.01	0.01	150.00
39	0.01	0.01	150.00
40	0.01	0.01	150.00

U1	ORD 01	U	150V
		I	5A
		PF	1.00
			1.00
			0.00deg
TOTAL	WIRING		
104.75 V	1P2W		
THD-F	CIRCUIT		
2.35 %	x4		
f	U1		
59.950 Hz	60Hz		
	INTVL.		
	1min		

Harmonic level, Harmonic content, and phase-angle data of the specified order  
 The order is changed using  $\leftarrow/\rightarrow$  of the cursor key.

Total value up to the 40th piece of data

Total harmonic distortion (THD-F or THD-R)

\* Not shown for power data

Harmonic level    Harmonic content    Phase angle

Frequency



## 6.7.2 Displaying a Harmonic Graph

MEASURE



Press the **MEASURE** key to display the measurement screen.

**F1 SCREEN**

Press the **F1 (SCREEN)** key to display the selection window.



Select "**HARMONIC GRAPH**" using the cursor key.

**F1 select**

Press the **F1 (select)** key to display the harmonic graph display screen.

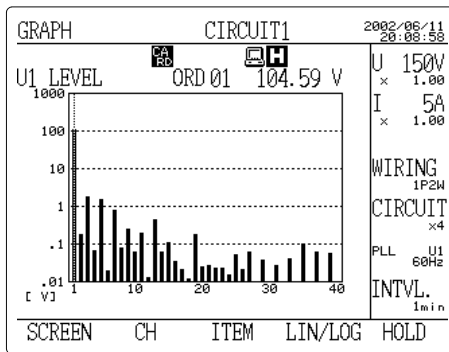

❖ (1) Change the Channel to be Displayed. (page 115)

❖ (2) Change the Item to be Displayed. (page 115)



## NOTE

Graphs of the harmonic level, content, and phase angle are available for the voltage, current, and power.

Harmonic level	Level of each order of harmonic
Harmonic content	Content of each order of harmonic as a percentage of the fundamental
Harmonic-voltage (current) phase angle	Phase angle of each order of harmonic with respect to the phase of the fundamental component of $U_1$
Harmonic-power phase angle	Power factor of each order of harmonic expressed as an angle

## Harmonic-current-level graph screen

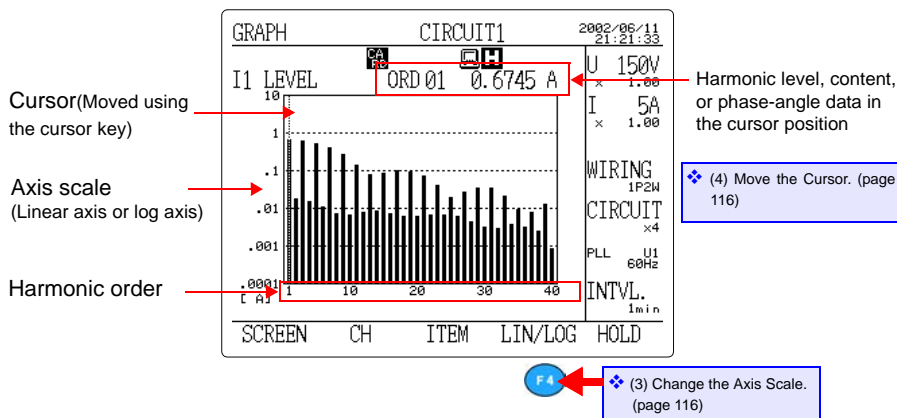

## Harmonic-current phase-angle graph screen

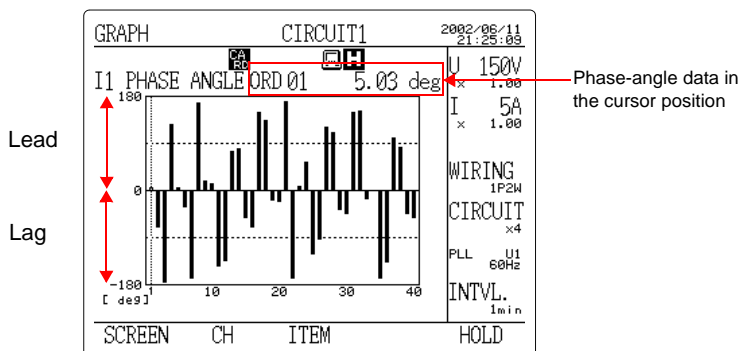

Phase-angle data for each order of harmonic

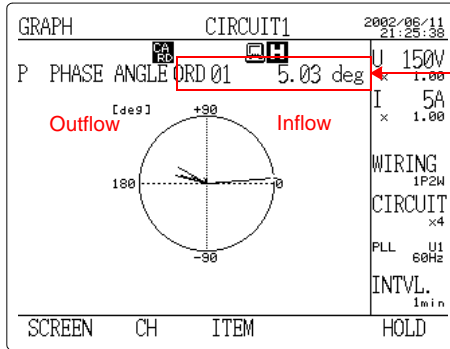

The order is changed using  $\leftarrow/\rightarrow$  of the cursor key. The vector of the on-screen order is marked with "+" at its tip.

## NOTE

- In the event of inflow, an order of harmonic flows into the load. In the event of outflow, the harmonic flows out from the load.
- The length of the vector represents the ratio of the apparent power of the order of harmonic as a percentage of the apparent power of the fundamental component.
- The x-axis represents active power and the y-axis represents reactive power. They are plotted on log axes.
- When the reactive-power-meter method is turned ON on the measurement setting screen, the harmonic-power phase angle is expressed as a number between 0 and  $\pm 180$  degrees. When the reactive-power-meter method is OFF, the phase angle is expressed as a number between 0 and  $\pm 180$  degrees.

## (1) Change the Channel to be Displayed.

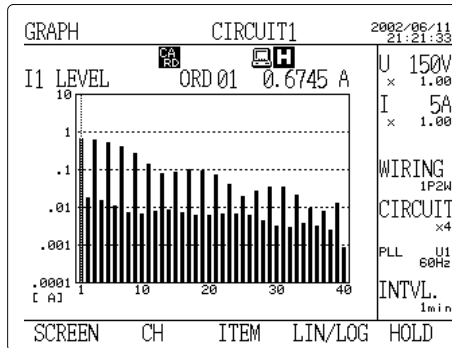

Press the **F2** (CH) key to display the selection window.

1P2W	U1, I1, P
1P3W	U1, U2, I1, I2, P
3P3W2M	U1, U2, U3, I1, I2, I3, P
3P3W3M	U1, U2, U3, I1, I2, I3, P
3P4W	U1, U2, U3, I1, I2, I3, P
3P4W4I	U1, U2, U3, I1, I2, I3, I4, P

\*: When multiple circuits are set, I and P are followed by a circuit number. (Ex., I1\_1, I1\_2, P\_1, P\_2)

Select a channel to be displayed using the cursor key.

Press the **F1** (select) key.

## (2) Change the Item to be Displayed.

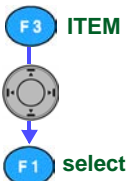

Press the **F3** (ITEM) key to display the selection window.

Level, Percentage, Phase angle

Select an item to be displayed using the cursor key.

Press the **F1** (select) key.

### (3) Change the Axis Scale.

**LIN/  
LOG**



Press the **F4** (LIN/LOG) key to change the axis scale.

#### NOTE

- When the y-axis represents the linear scale (log scale), if the **F4** (LIN/LOG) key is pressed, the scale is changed to log (linear).
- The full scale of the linear axis depends on the range.

### (4) Move the Cursor.



Press   of the cursor key to move the cursor (dotted line) on the screen. The level of each order of harmonic, content, or phase angle at the cursor position is shown as a number.

### (5) Change the Harmonic Order to be Displayed.

Select "All order" or "Odd order" as the harmonic order to be displayed.

❖ 5.5.2 Setting the Harmonic Order for Display (page 91)

## 6.8 Displaying on a Zoom Screen

ZOOM		2002/06/13 06:18:33	
<b>U1</b>		199.89	V
I1	_1	4.9917	A
P1	_1	0.8655	kW
PF1	_1	0.8675	
f		49.995	Hz
SCREEN	ITEM	HOLD	

MEASURE



Press the **MEASURE** key to display the measurement screen.



SCREEN

Press the **F1** (SCREEN) key to display the selection window.



Select "**ZOOM**" using the cursor key.



select

Press the **F1** (select) key.



Select an item to be changed using the cursor key.



ITEM

Press the **F2** (ITEM) key to display the selection window.



Select an item to be displayed using the cursor key.



select

Press the **F1** (select) key to display the selected item on a zoom screen.

### NOTE

- Display on a zoom screen is available for the instantaneous value and integrated power in normal measurement only.
- On a zoom screen, the **U RANGE** and **I RANGE** keys are disabled.

## 6.9 Holding Displayed Measurement Data

**F5 HOLD**

MAIN	INST.	CIRCUIT		2002-06-13 00:06:53
U1	208.00 V	I1	4.9935 A	U × 300V × 1.00
U2	207.97 V	I2	4.9958 A	I × 5A × 1.00
U3*	207.80 V	I3*	4.9940 A	
Uave	207.93 V	Iave	4.9944 A	
P	1.5610kW	Q	0.8937kvar	WIRING 3P3W2M
		S	1.7987kVA	CIRCUIT ×2
		PF	0.8678	PLL 50Hz U1
		f	49.998 Hz	INTVL. 1min
WP+	0.00000kWh		0:00:00	
SCREEN	CIRCUIT AVERAGE			HOLD

Lights up when the displayed measurement is held



When the **F5** (HOLD) key is pressed on a measurement screen, the on-screen measurement data will be held. Pressing the **F5** key again releases the Hold.

### NOTE

- The **START/STOP** key is disabled during Hold.
- If the **SAVE** key is pressed for manual data storage during Hold, the held instantaneous value is saved.
- The automatic-output function during time-series measurement outputs data of every interval, regardless of whether the Hold function is ON.

# Loading and Saving Settings and Measured Data

## 7

### 7.1 Types of Files

#### Types of Files

File	Mode		File Name	Format	Remarks
Setting file			69SET00.SET to 69SET99.SET #####.SET	Text	
Measurement data file	Automatic output	Standard interval	69MEAS00.CSV to 69MEAS99.CSV #####.CSV	Text	
		Short-term interval	69INST00.BIN to 69INST99.BIN #####.BIN	Binary	
	Manual (Not during time-series measurement)		69MANU00.CSV to 69MANU99.CSV	Text	
Waveform data file	Automatic output	Standard interval	69WAVE00.WUI to 69WAVE99.WUI #####.WUI	Binary	
	Manual (Not during time-series measurement)		69MANU00.WUI to 69MANU99.WUI	Binary	
Backup data file	Automatic output	Standard interval (measurement data)	69BACK00.CSV to 69BACK99.CSV	Text	Stored in the interval memory only
		Standard interval (waveform data)	69BACK00.WUI to 69BACK99.WUI	Binary	
		Short-term interval (measurement data)	69BACK00.BIN to 69BACK99.BIN	Binary	
Screen copy file	Manual		69BMP00.BMP to 69BMP99.BMP	BMP	

- ##### represents a file name set by a user.
- The same file cannot be stored in both the PC card and the internal memory.
- When the medium for saving data is set to PC card, if the PC card is not installed or the 3169-20/21 fails to write data to the PC card, the data will be stored in the internal memory as a backup data file (automatic output data only).
- The PC card and internal memory each hold up to 100 files: measurement data files, waveform data files, backup data files, and screen copy files.  
The PC card holds up to 10 setting files. The internal memory holds up to 5 setting files.
- When reading a file in binary format into commercially available spreadsheet software, convert the file into a text file. The CD-R supplied with the 3169-20/21 contains the conversion software.
- For the headers of measurement data, see the list in the "Appendix" (page 203).

## Status Data (STATUS)

Status data is added to measurement data files (standard interval). Status data consists of a 10-bit binary number, as shown below. It indicates the occurrence of over-range, excessive input (excessive crest factor), power outage, or other situations that may occur during time-series measurement.

Bit	bit9	bit8	bit7	bit6	bit5	bit4	bit3	bit2	bit1	bit0
Item	PLL	pd	or	ovl4	ovl3	ovl2	ovl1	ovU3	ovU2	ovU1

ov: Excessive input: The file contains data with an excessive crest factor.

or: Over-range: The file contains data exceeding 130% of the range.

pd: A power outage has occurred.

PLL: PLL unlock: PLL unlock has occurred.

For example, if a power outage occurred during time-series measurement, the status data will be shown as "0100000000."

### NOTE

The zero of the upper bit may not be indicated on commercially available spreadsheet software.



## 7.2 Using a PC Card

### 7.2.1 Selecting a PC Card

#### WARNING

Use only PC Cards sold by HIOKI.

Compatibility and performance are not guaranteed for PC cards made by other manufacturers. You may be unable to read from or save data to such cards.

HIOKI options

PC cards (includes adapter)

- 9626 PC CARD 32M
- 9627 PC CARD 64M
- 9726 PC CARD 128M
- 9727 PC CARD 256M
- 9728 PC CARD 512M

#### CAUTION

- PC Cards should always be formatted before use (format the Card within the instrument.)
- When formatting a PC card on a PC, use the FAT or FAT-16 format. Formatting a card in FAT-32 format may result in incompatibility problems.
- Do not handle Cards in dusty environments, or where caustic vapors may be present. The connector contacts can be fouled in such conditions.
- 9729 PC Card 1G, 9830 PC Card 2G are not compatible with this instrument.
- Some PC card drives are susceptible to static electricity. Exercise care when using such products because static electricity could damage the PC card drive or cause malfunction of the instrument.
- With some PC card drives, the instrument may not start up if power is turned on while the PC card drive is inserted. In such a case, turn power on first, and then insert the PC card drive. It is recommended to try out operation with a PC card drive before starting to use it for actual measurements.

## 7.2.2 Inserting and Removing the PC Card

### CAUTION

- The PC Card or the instrument can be damaged if the card is inserted forcefully in the wrong direction.
- Never eject a PC Card while it is being accessed by the instrument. Data on the PC Card may be lost.
- Keep the cover closed when a PC Card is not installed.
- When the instrument is to be transported, remove the PC Card and close the cover.

### Inserting and Removing the PC Card

#### Inserting the PC Card

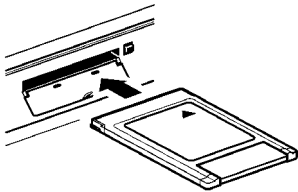

Open the cover and insert the PC card with the arrow facing up and in the direction of the PC card slot, as far as it will go.

#### Removing the PC Card

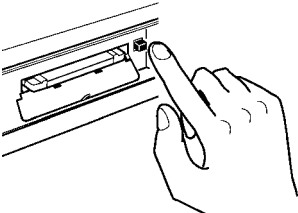

Press the eject button and pull out the PC card.

## 7.3 File Operation

FILE



Press the **FILE** key to display the file main screen.

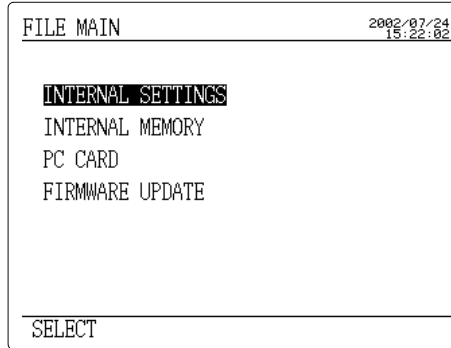

**INTERNAL SETTINGS**

Loading, saving, deleting, and copying setting files in the internal memory

**INTERNAL MEMORY**

Formatting and copying the internal memory

**PC CARD**

Deleting files, loading and saving setting files on the PC card, and formatting the PC card

**FIRMWARE UPDATE**

Upgrading the 3169-20/21

### NOTE

The file list screen shows only the files with the same extension as that of the files used on the 3169-20/21.

### 7.3.1 Initializing (Formatting) the Internal Memory

Use this function to delete files from the internal memory. In the internal memory, individual files cannot be deleted separately (except for setting files).

FILE



Press the **FILE** key to display the file main screen.



Move the cursor to "**INTERNAL MEMORY.**"

F1

SELECT

Press the **F1** (SELECT) key to display the internal memory-file list screen.

INTERNAL MEMORY				2002/06/13 19:16:37
69MEAS00.CSV	2002/06/13	19:07	4KB	
69MEAS01.CSV	2002/06/13	19:07	4KB	
69BMP00.BMP	2002/06/13	19:07	10KB	
69BMP01.BMP	2002/06/13	19:07	10KB	
69MEAS02.CSV	2002/06/13	19:07	4KB	
69BMP02.BMP	2002/06/13	19:08	10KB	

SELECT	ALL	COPY	FORMAT	RETURN
--------	-----	------	--------	--------

F4

FORMAT

Press the **F4** (FORMAT) key; a confirmation message will appear.

F1

yes

Press the **F1** (yes) key to start formatting.

\*: While the memory is being formatted, the display shows the message "Busy... Please wait." (The message disappears upon completion of formatting.)

F5

RETURN

Press the **F5** (RETURN) key to return to the file main screen.

#### NOTE

- If the internal memory is formatted, all files in the memory will be deleted. The deleted files cannot be restored.
- Even if data is to be saved on the PC card, we recommend that the internal memory be formatted before time-series measurement is begun, in order to secure space in the memory for backup files in case data fails to be saved on the PC card. If the internal memory is full, data unable to be saved on the PC card will not be backed up.

### 7.3.2 Initializing (Formatting) the PC Card

The PC card must be formatted when it is used for the first time after purchase. In addition, format the PC card when all files on it are to be deleted.

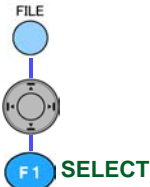

Press the **FILE** key to display the file main screen.

Move the cursor to "**PC CARD**."

Press the **F1** (SELECT) key to display the PC card-file list screen.

PC CARD				2002/06/13
				20:53:20
69BMP00	.BMP	2002/06/13 00:01	10KB	
69BMP01	.BMP	2002/06/13 00:05	10KB	
69BMP02	.BMP	2002/06/13 00:52	10KB	
69MEAS00	.CSV	2002/06/13 00:07	2KB	
MAINMIN	.BMP	2002/06/13 00:08	10KB	
POWERAVE	.BMP	2002/06/13 00:12	10KB	
69MEAS01	.CSV	2002/06/13 00:12	2KB	
POWERMIN	.BMP	2002/06/13 00:12	10KB	
69BMP03	.BMP	2002/06/13 10:11	10KB	
69MEAS02	.CSV	2002/06/13 00:14	2KB	
SET. SAVE LOAD FORMAT <-- RETURN				



If (→) is shown above the **F4** key, use the **F4** (→) key to change the functions for the function keys.



Press the **F3** (FORMAT) key; a confirmation message will appear.



Press the **F1** (yes) key to start formatting.

\*: While the memory is being formatted, the display shows the message "Busy... Please wait." (The message disappears upon completion of formatting.)



Press the **F5** (RETURN) key to return to the file main screen.

#### NOTE

If the PC card is formatted, all files on the PC card will be deleted. The deleted files cannot be restored.

### 7.3.3 Saving a Setting File

Save the current settings of the 3169-20/21 in the internal memory or on the PC card.

#### (1) Save in the Internal Memory.

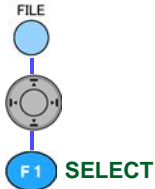

Press the **FILE** key to display the file main screen.

Move the cursor to "**INTERNAL SETTINGS.**"

Press the **F1** (SELECT) key to display the internal setting-file list screen.

INTERNAL SETTINGS		2002/06/13 19:10:04
AB	.SET 2002/06/13 19:08	1KB
CC	.SET 2002/06/13 19:09	1KB
01	.SET 2002/06/13 19:09	1KB
KLMO	.SET 2002/06/13 19:09	1KB
SET. SAVE LOAD DELETE <-- RETURN		

If (→) is shown above the **F4** key, use the **F4** (→) key to change the functions for the function keys.

Press the **F1** (SET. SAVE) key to display the file-name input window.

Set the file name using the cursor and function keys.

Cursor	Select characters
input	Inputs the selected character.
BS	Backspace (deletes the selected character)

Press the **F3** (enter) key to save the setting file in the internal memory.

Press the **F5** (RETURN) key to return to the file main screen.

#### NOTE

- The extension for setting files is ".SET" (the extension is added automatically).
- If the **F3** (enter) key is pressed without setting a file name, the 3169-20/21 automatically names the file. "69SETXX.SET" (XX: 00 to 99)
- The internal memory holds up to 5 setting files.

## (2) Save on the PC Card.

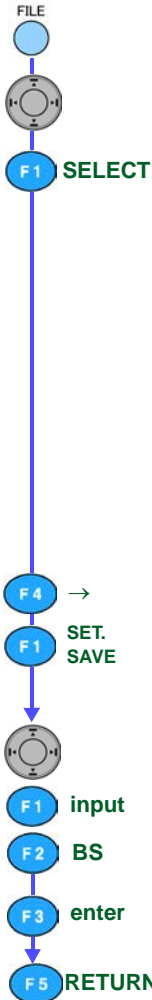

Press the **FILE** key to display the file main screen.

Move the cursor to "**PC CARD.**"

Press the **F1** (SELECT) key to display the PC card-file list screen.

PC CARD		2002/06/13
		18:55:18
69BMP00	.BMP	2002/06/13 00:01 10KB
69BMP01	.BMP	2002/06/13 00:05 10KB
69BMP02	.BMP	2002/06/13 00:52 10KB
69MEAS00	.CSV	2002/06/13 00:07 2KB
MAINMIN	.BMP	2002/06/13 00:08 10KB
POWERAVE	.BMP	2002/06/13 00:12 10KB
69MEAS01	.CSV	2002/06/13 00:12 2KB
POWERMIN	.BMP	2002/06/13 00:12 10KB
69BMP03	.BMP	2002/06/13 10:11 10KB
69MEAS02	.CSV	2002/06/13 00:14 2KB
SET. SAVE	LOAD	FORMAT <-- RETURN

If (→) is shown above the **F4** key, use the **F4** (→) key to change the functions for the function keys.

Press the **F1** (SET. SAVE) key to display the file-name input window.

Set the file name using the cursor and function keys.

Cursor	Select characters
input	Inputs the selected character.
BS	Backspace (deletes the selected character)

Press the **F3** (enter) key to save the setting file in the PC card.

Press the **F5** (RETURN) key to return to the file main screen.

### NOTE

- The extension for setting files is ".SET" (the extension is added automatically).
- If the **F3** (enter) key is pressed without setting a file name, the 3169-20/21 automatically names the file. "69SETXX.SET" (XX: 00 to 99)
- The PC card holds up to 5 setting files.

### 7.3.4 Loading a Setting File

Load a setting file on the PC card or in the internal memory into the 3169-20/21, and set the instrument with the settings.

#### (1) Load a File in the Internal Memory.



Press the **FILE** key to display the file main screen.



Move the cursor to "**INTERNAL SETTINGS.**"



**SELECT**

Press the **F1** (SELECT) key to display the internal setting-file list screen.

INTERNAL SETTINGS			2002/06/13 19:10:04
AB	.SET	2002/06/13 19:08	1KB
CC	.SET	2002/06/13 19:09	1KB
01	.SET	2002/06/13 19:09	1KB
KLMNO	.SET	2002/06/13 19:09	1KB
SET. SAVE LOAD DELETE <-- RETURN			



→

If (→) is shown above the **F4** key, use the **F4** (→) key to change the functions for the function keys.



Select a file to be load using the cursor key.



**LOAD**

Press the **F2** (LOAD) key; a confirmation message will appear.



**yes**

Press the **F1** (yes) key to load the setting file in the internal memory.



**RETURN**

Press the **F5** (RETURN) key to return to the file main screen.

#### NOTE

Files cannot be load during time-series measurement.



## (2) Load a File on the PC Card.

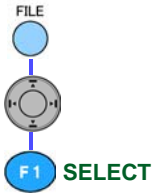

Press the **FILE** key to display the file main screen.

Move the cursor to "**PC CARD.**"

Press the **F1** (SELECT) key to display the PC card-file list screen.

PC CARD				2002/06/14 00:04:20
69BMP14	.BMP	2002/06/13	19:06	10KB
69BMP15	.BMP	2002/06/13	20:53	10KB
69BMP16	.BMP	2002/06/13	19:08	10KB
69BMP17	.BMP	2002/06/13	19:08	10KB
69BMP18	.BMP	2002/06/13	19:09	10KB
69BMP21	.BMP	2002/06/13	19:09	10KB
012	.SET	2002/06/14	00:06	1KB
69BMP23	.BMP	2002/06/13	19:10	10KB
CARDDEL	.BMP	2002/06/13	20:55	10KB
CARDSAVE	.BMP	2002/06/13	18:50	10KB
SET. SAVE LOAD FORMAT <--				RETURN



If (→) is shown above the **F4** key, use the **F4** (→) key to change the functions for the function keys.



Select a file to be load using the cursor key.



Press the **F2** (LOAD) key; a confirmation message will appear.



Press the **F1** (yes) key to load the setting file on the PC card.



Press the **F5** (RETURN) key to return to the file main screen.

### NOTE

Files cannot be load during time-series measurement.

## 7.3.5 Deleting a File

### (1) Delete a Setting File from the Internal Memory.

FILE



Press the **FILE** key to display the file main screen.



Move the cursor to "**INTERNAL SETTINGS.**"

**F1 SELECT**

Press the **F1** (SELECT) key to display the internal setting-file list screen.

INTERNAL SETTINGS		2002/06/13 23:48:41
AB	.SET 2002/06/13 19:08	1KB
CC	.SET 2002/06/13 19:09	1KB
01	.SET 2002/06/13 19:09	1KB
*KLMNO	.SET 2002/06/13 19:09	1KB

SET.SAVE LOAD DELETE <-- RETURN

**F4** ←

If (←) is shown above the **F4** key, use the **F4** (←) key to change the functions for the function keys.



Select a file to be deleted from the file list.

**F1 SELECT**

SELECT	Select one file.
ALL	Select all files.

**F2 ALL**

(the selected file will be marked with an asterisk "\*" to its left)

**F4** →

Use the **F4** (→) key to change the functions for the function keys.

**F3 DELETE**

Press the **F3** (DELETE) key; a confirmation message will appear.

**F1 yes**

Press the **F1** (yes) key to delete the selected file.

**F5 RETURN**

Press the **F5** (RETURN) key to return to the file main screen.

## NOTE

While the cursor is on the selected file, if the **F1** (SELECT) or **F2** (ALL) key is pressed again, the selection is canceled.

## (2) Delete a File from the PC Card.



Press the **FILE** key to display the file main screen.

Move the cursor to "**PC CARD.**"

Press the **F1** (SELECT) key to display the PC card-file list screen.

PC CARD		2002/06/13
		20:55:03
*69BMP00 .BMP	2002/06/13 00:01	10KB
69BMP01 .BMP	2002/06/13 00:05	10KB
69BMP02 .BMP	2002/06/13 00:52	10KB
69MEAS00 .CSV	2002/06/13 00:07	2KB
MAINMIN .BMP	2002/06/13 00:08	10KB
POWERAVE .BMP	2002/06/13 00:12	10KB
69MEAS01 .CSV	2002/06/13 00:12	2KB
POWERMIN .BMP	2002/06/13 00:12	10KB
69BMP03 .BMP	2002/06/13 10:11	10KB
69MEAS02 .CSV	2002/06/13 00:14	2KB

SELECT	ALL	DELETE	-->	RETURN
--------	-----	--------	-----	--------

If (←) is shown above the **F4** key, use the **F4** (←) key to change the functions for the function keys.

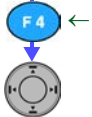

Select a file to be deleted from the file list.

**F1** SELECT

SELECT	Select one file.
--------	------------------

ALL	Select all files.
-----	-------------------

**F2** ALL

(the selected file will be marked with an asterisk "\*" to its left)

**F3** DELETE

Press the **F3** (DELETE) key; a confirmation message will appear.

**F1** yes

Press the **F1** (yes) key to delete the selected file.

**F5** RETURN

Press the **F5** (RETURN) key to return to the file main screen.

### NOTE

While the cursor is on the selected file, if the **F1** (SELECT) or **F2** (ALL) key is pressed again, the selection is canceled.

## 7.3.6 Copying a File in the Internal Memory to a PC Card



Press the **FILE** key to display the file main screen.

Move the cursor to "**INTERNAL MEMORY.**"

Press the **F1** (SELECT) key to display the internal memory-file list screen.

INTERNAL MEMORY				2002/07/25 22:16:47
69MEAS00.	CSV	2002/07/25 22:12		3KB
69INST00.	BIN	2002/07/25 22:13		18KB
69MEAS01.	CSV	2002/07/25 22:13		2KB
69MEAS02.	CSV	2002/07/25 22:13		5KB
69BMP00.	BMP	2002/07/25 22:13		10KB
69BMP01.	BMP	2002/07/25 22:13		10KB
*69BMP02.	BMP	2002/07/25 22:13		10KB
SELECT ALL COPY FORMAT RETURN				

Select a file to be copied from the file list.

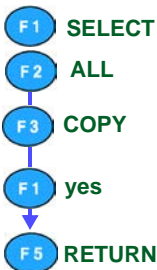

SELECT	Select one file.
ALL	Select all files.

(the selected file will be marked with an asterisk "\*" to its left)

Press the **F3** (COPY) key. A confirmation message will appear.

Press the **F1** (yes) key to copy the selected file in the interval memory to the PC card.

Press the **F5** (RETURN) key to return to the file main screen.

### NOTE

- While the cursor is on the selected file, if the **F1** (SELECT) or **F2** (ALL) key is pressed again, the selection is canceled.
- If the same file name exists on the PC card, the file on the PC card will be overwritten.

## 7.4 Saving Measurement Data

### 7.4.1 Automatic Storage of Measurement Data

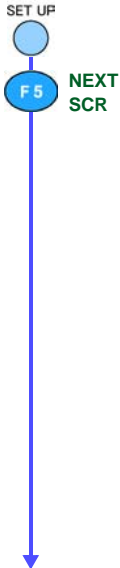

Press the **SET UP** key to display the setting screen.

Press the **F5** (NEXT SCR) key to display the data-output setting screen.

Set the time-series measurement start method, stop method, interval, data-output file name, and medium for saving data (PC card or internal memory (1 MB)).

❖5.3 Setting on the Data Output Setting Screen (DATA OUTPUT) (page 72)

SET UP 2/5 DATA OUTPUT		2002/07/24 20:01:47	
MEAS. START	MANUAL		
MEAS. STOP	MANUAL		
INTERVAL TIME	1 min		
SAVE IN...	PC CARD		
DATA FILE NAME			
RS CONNECTION	PC		
DISPLAY COPY	PC CARD		
MANUAL TIME	JUST		NEXT SCR

F5 NEXT  
SCR

Press the **F5** (NEXT SCR) key to display the save/print items setting screen. Set the items to be stored.

❖ 5.4 Setting on the Save/Print Items Setting Screen (SAVE, PRINT ITEMS) (page 83)

SET UP 3/5 SAVE, PRINT ITEMS		2003/05/13	
		15:24:05	
			NO. OF ITEMS 25
NORM. MEAS.	ON	INST.	OFF
		AVE.	ON
HARMONIC	OFF	MAX.	OFF
		MIN.	OFF
INTEG. & DEM.		ON	
SAVE TIME AVAIL. 114d 4h 4m 0s			
OFF ON		NEXT SCR	

MEASURE

Press the **MEASURE** key to display the measurement screen.

START  
STOP

Press the **START/STOP** key to start time-series measurement. Measurement data is saved in the set medium for saving data at every interval.

## Storable Data According to Interval Setting

Interval setting	Normal measurement data	Integrated power/demand measurement data	Harmonic measurement data
1/2/5/10/15/30/60 minutes	Yes	Yes	Yes
1/2/5/10/15/30 seconds	Yes	Yes	No
All wave/100/200/500 ms	Yes (Instantaneous values only) Binary data	No	No

## Storable Time

All Normal Measurement Items ON and Integrated power/Demand ON

Wiring	1P2W X 4	1P3W X 2	3P3W2M X 2	3P3W3M, 3P4W	3P4W4I
No. of Data Items	160	180	196	118	122
PC card 512 MB					
Interval time					
1 minute	180 days	160 days	150 days	250 days	240 days
2 minutes	1 year	320 days	300 days	1 year	1 year
5 minutes	1 year	1 year	1 year	1 year	1 year
10 minutes	1 year	1 year	1 year	1 year	1 year
15 minutes	1 year	1 year	1 year	1 year	1 year
30 minutes	1 year	1 year	1 year	1 year	1 year
60 minutes	1 year	1 year	1 year	1 year	1 year
Internal memory					
Interval time					
1 minutes	9 hours	8 hours	7 hours	12 hours	11 hours
2 minutes	18 hours	16 hours	14 hours	24 hours	23 hours
5 minutes	1 day and 21 hours	1 day and 16 hours	1 day and 12 hours	2 days and 13 hours	2 days and 11 hours
10 minutes	3 days	3 days	3 days	5 days	4 days
15 minutes	5 days	4 days	4 days	7 days	7 days
30 minutes	11 days	9 days	9 days	15 days	14 days
60 minutes	22 days	19 days	18 days	30 days	29 days

All Normal Measurement Items ON and Integrated power/Demand ON,  
All Harmonic Items ON (Interval: 1 minute)

Wiring	1P2W X 4	1P3W X 2	3P3W2M X 2	3P3W3M, 3P4W	3P4W4I
No. of Data Items	4536	4076	5556	3530	4022
PC card 512 MB	6 days	6 days	5 days	7 days	6 days
Internal memory	16 minutes	19 minutes	13 minutes	22 minutes	19 minutes

## 7.4 Saving Measurement Data

All Normal Measurement Items ON and Integrated power/Demand ON,  
All Harmonic Items OFF (Interval: 1 second)

Wiring	1P2W X 4	1P3W X 2	3P3W2M X 2	3P3W3M, 3P4W	3P4W4I
No. of Data Items	160	180	196	118	122
PC card 512MB	3 days and 2 hours	2 days and 18 hours	2 days and 12 hours	4 days and 5 hours	4 days and 1 hour
Internal memory	9 minutes	8 minutes	7 minutes	12 minutes	11 minutes

## Normal Measurement Instantaneous Value Only

Wiring	1P2W X 4	1P3W X 2	3P3W2M X 2	3P3W3M, 3P4W	3P4W4I	
No. of Data Items	25	18	21	14	15	
PC card 512 MB Interval time All wave	100ms	19 hours	24 hours	22 hours	1 day and 6 hours	1 day and 4 hours
	200ms	4 days and 23 hours	6 days	5 days	7 days	7 days
	500ms	5 days 12 days	6 days 16 days	5 days 14 days	7 days 19 days	7 days 18 days
Internal memory Interval time All wave	100ms	2 minutes	3 minutes	2 minutes	3 minutes	3 minutes
	200ms	14 minutes	18 minutes	16 minutes	22 minutes	21 minutes
	500ms	29 minutes 1 hours and 12 minutes	37 minutes 1 hours and 34 minutes	33 minutes 1 hours and 24 minutes	45 minutes 1 hours and 54 minutes	43 minutes 1 hours and 49 minutes

## NOTE

- Short-term interval (All wave/100 ms/200 ms/500 ms) data and harmonic waveform data are saved in binary format files. Binary format files must be converted to text files to be read into commercially available spreadsheet software. The conversion software is provided in the supplied CD-R.
- If the number of output-data items on the save/print items setting screen exceeds 256, it may not be possible to read all data into commercially available spreadsheet software. Make sure that the number of output-data items does not exceed 256 when they are to be read into such spreadsheet software.
- The longest measurement period of this unit is one year.  
The instrument will automatically stop time-series measurement when one year has elapsed since the start of the time-series measurement.



## 7.4.2 Saving Measurement Data Manually

Save instantaneous data manually.

Press the **SET UP** key to display the setting screen.

Press the **F5 (NEXT SCR)** key to display the data-output setting screen.

Set the medium for saving data (PC card or internal memory (1 MB)).

❖ 5.3 Setting on the Data Output Setting Screen (DATA OUTPUT) (page 72)



SET UP 2/5 DATA OUTPUT		2002-07-24 20:01:47	
MEAS. START	MANUAL		
MEAS. STOP	MANUAL		
INTERVAL TIME	1 min		
SAVE IN..	PC CARD		
DATA FILE NAME			
RS CONNECTION	PC		
DISPLAY COPY	PC CARD		
MANUAL TIME	JUST	NEXT SCR	

F5

NEXT  
SCR

Press the **F5** (NEXT SCR) key to display the save/print items setting screen.

To output harmonic-measurement data, set the items to be stored on the harmonic-measurement detail setting screen.

❖ 5.4 Setting on the Save/Print Items Setting Screen (SAVE, PRINT ITEMS) (page 83)

SET UP 3/5 SAVE, PRINT ITEMS		2003/05/13	
		15:24:05	
		NO. OF ITEMS	25
NORM. MEAS.	ON	INST. AVE.	OFF ON
HARMONIC	OFF	MAX. MIN.	OFF OFF
INTEG. & DEM.		ON	
SAVE TIME AVAIL.		114d 4h 4m 0s	
OFF	ON	NEXT SCR	

Press the **MEASURE** key to display the measurement screen.

Press the **SAVE** key to save the measurement data manually.

## NOTE

- Data cannot be saved manually during time-series measurement.
- The files are named automatically.  
Measurement data: 69MANUXX.CSV (XX: 00 to 99)  
Waveform data: 69MANUXX.WUI (XX: 00 to 99) binary data
- The instantaneous values are saved regardless of the ON/OFF setting of the instantaneous, average, maximum, and minimum values on the save/print items setting screen. In the case of harmonic measurement data, the instantaneous data of the items selected on the save/print items setting screen are saved.

MEASURE



SAVE



## 7.5 Copying Screen

Copy the screen onto the PC card or to internal memory.

Press the **SET UP** key to display the setting screen.

Press the **F5** (NEXT SCR) key to display the data-output setting screen.

SET UP	2/5 DATA OUTPUT	2002/07/24
		20:01:47
MEAS. START	MANUAL	
MEAS. STOP	MANUAL	
INTERVAL TIME	1 min	
SAVE IN...	PC CARD	
DATA FILE NAME		
RS CONNECTION	PC	
DISPLAY COPY	PC CARD	
MANUAL TIME	JUST	NEXT SCR

Move the cursor to "**DISPLAY COPY.**"

Set the medium for copying the screen using the function keys.

PC CARD	Save on the PC card.
MEMORY	Save in the internal memory (1 MB).

❖ 5.3.7 Setting the Medium to which the Screen is to be Copied (page 82)

Display a screen to be copied.

Press the **COPY** key to save the screen currently on display.

SET UP



NEXT  
SCR



CARD



MEMORY





# Using a Printer

## 8

### ! CAUTION

- To avoid damaging the instrument and printer, do not connect and disconnect the connectors when the power is on.
- As much as possible, avoid printing in hot and humid environments. Otherwise, printer life may be severely shortened.

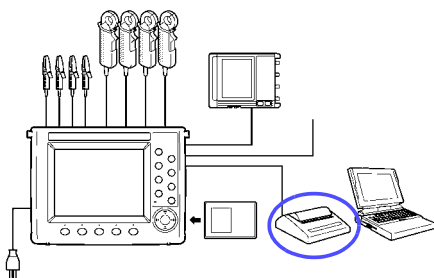

The instrument can produce hard copies of the screen and print measurement data on the Model 9442 PRINTER connected to the RS-232C interface.

## 9442 PRINTER (option)

The following items are required to use the 9442 PRINTER.

- 9442 PRINTER  
(with 1 roll of thermally sensitized paper supplied)
- 9443-02 AC ADAPTER (AC230 V, 50 Hz)
- 9443-03 AC ADAPTER (AC120 V, 60 Hz)
- 1196 RECORDING PAPER  
(thermally sensitized paper 112 x 25 m, 10 rolls)
- 9721 RS-232C CABLE (for printer)

### NOTE

- For printer handling, see the operations manual for the printer.
- Use 1196 RECORDING PAPER or the equivalent for the printer.

## 8.1 Connecting the Printer

### Connecting the 9442 PRINTER to the 3169-20/21

Required for connection:  
9721 RS-232C CABLE

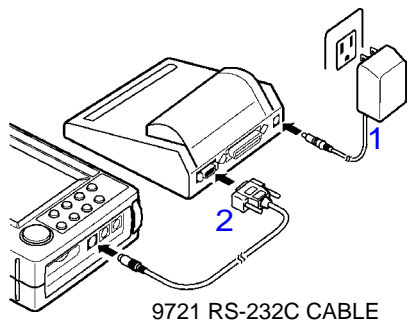

9443-03 AC ADAPTER

1. Connect the 9443-02/03 AC ADAPTER to the 9442 PRINTER.
2. Connect the RS-232C connector of the 3169-20/21 and the serial connector of the printer using the 9721 RS-232C CABLE.
3. Turn the instrument and printer on.

## Setting the 9442 PRINTER

The 9442 printer is factory-set for use with the 3166 or 3169-20/21 CLAMP ON POWER HiTESTER. When the printer is used with the 3169-20/21, it is not necessary to edit the settings. The software DIP switches of the 9442 printer are set as shown below.

For the DIP-switch setting procedure, see the DPU-414 operations manual supplied with the 9442 printer.

### (1) Software DIP SW1

Switch No.	Setting	Function	ON	OFF
1	OFF	Input method	Parallel	Serial
2	ON	Printing speed	High speed	Low speed
3	ON	Auto-loading	Enabled	Disabled
4	OFF	CR function	Carriage return and line feed	Carriage return
5	ON	Setting command	Enabled	Disabled
6	OFF	Printing density selection 100%		
7	ON			
8	ON			

### (2) Software DIP SW2

Switch No.	Setting	Function	ON	OFF
1	ON	Printing mode	Normal printing (40 columns)	Condensed printing (80 columns)
2	ON	User-defined character backup	Enabled	Disabled
3	ON	Character type	Ordinary	Special
4	ON	Zero font	0	φ
5	ON	Japanese - International Character Set		
6	ON			
7	ON			
8	ON			

The 3169-20/21 automatically turns off the printing-mode switch (condensed printing).

### (3) Software DIP SW3

Switch No.	Setting	Function	ON	OFF
1	ON	Data bit length	8 bits	7 bits
2	ON	Parity	Without	With
3	ON	Parity condition	Odd	Even
4	OFF	Flow control	H/W BUSY	XON/XOFF
5	OFF	Baud rate: 9600 bps		
6	ON			
7	ON			
8	ON			

## 8.2 Setting the Printer

### 8.2.1 Setting the Device to Be Connected to the RS-232C

SET UP 2/5 DATA OUTPUT		2002/07/24 19:18:53
MEAS. START	MANUAL	
MEAS. STOP	MANUAL	
INTERVAL TIME	30 min	
SAVE IN...	PC CARD	
DATA FILE NAME		
RS CONNECTION	PC	
DISPLAY COPY	PC CARD	
PC	PRINTER	NEXT SCR

SET UP



Press the **SET UP** key to display the setting screen.

F 5

NEXT  
SCR

Press the **F5** (NEXT SCR) key to display the data-output setting screen.



Move the cursor to "**RS CONNECTION.**"

F 2

PRINTER



Press the **F2** (PRINTER) key to set the device to be connected to the RS-232C to printer.

#### NOTE

- The device to be connected to the RS-232C is set to the PC by default.
- When the interval is set to 30 seconds or less, measurement data cannot be output to a printer.
- To output measurement data to a printer automatically, set the interval to 1 minute or more.



## 8.2.2 Setting the RS-232C

SET UP 4/5 SYSTEM		2002/07/24 19:24:16
THD	THD-F	
HARM. DISP. ORD.	ALL ORDERS	
RS-232C		
BAUD RATE	9600bps	
TERMINATOR	CR+LF	
FLOW CONTROL	NONE	
BACKLIGHT	AUTO	
BEEP SOUND	ON	
ID	001	
TIME AND DATE	2002/07/24 19:22:56	
LANGUAGE	ENGLISH	
SERIAL NUMBER	020437412 Ver. 1.02	
change	NEXT SCR	

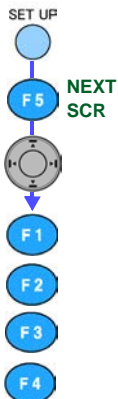

Press the **SET UP** key to display the setting screen.

Press the **F5** (NEXT SCR) key to display the system setting screen.

Move the cursor to "**RS-232C**."

Set the following using the function keys.

Setting Item	Presets
BAUD RATE	9600 bps
TERMINATOR	CR+LF
FLOW CONTROL	XON/XOFF

❖ 5.5.3 Setting the RS-232C (page 92)

## 8.3 Automatic Output of Measurement Data to the Printer

SET UP



Press the **SET UP** key to display the setting screen.

Set the printer.

❖8.2 Setting the Printer (page 144)

F5

NEXT  
SCR

Press the **F5** (NEXT SCR) key to display the data-output setting screen.

Set the time-series measurement start/stop methods and interval.

❖5.3 Setting on the Data Output Setting Screen (DATA OUTPUT) (page 72)

SET UP	2/5 DATA OUTPUT	2002/07/24 20:01:47
MEAS. START	MANUAL	
MEAS. STOP	MANUAL	
INTERVAL TIME	1 min	
SAVE IN..	PC CARD	
DATA FILE NAME		
RS CONNECTION	PC	
DISPLAY COPY	PC CARD	
MANUAL	TIME	JUST
		NEXT SCR

## 8.3 Automatic Output of Measurement Data to the Printer

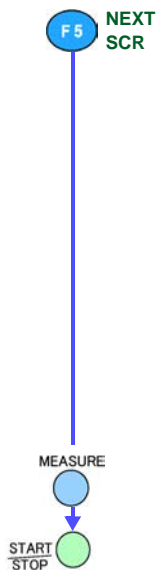

Press the **F5** (NEXT SCR) key to display the save/print items setting screen. Set the items to be printed out.

❖ 5.4 Setting on the Save/Print Items Setting Screen (SAVE, PRINT ITEMS) (page 83)

SET UP 3/5 SAVE, PRINT ITEMS		2003/05/13	
		15:24:03	
		NO. OF ITEMS	25
NORM. MEAS.	<input checked="" type="checkbox"/> ON	INST.	OFF
		AVE.	ON
HARMONIC	OFF	MAX.	OFF
		MIN.	OFF
INTEG. & DEM.		ON	
SAVE TIME AVAIL. 114d 4h 4m 0s			
OFF ON		NEXT SCR	

Press the **MEASURE** key to display the measurement screen.

Press the **START/STOP** key to start time-series measurement. Measurement data will be printed out on the printer at every interval.

**NOTE**

- When the interval is set to 30 seconds or less, data cannot be output to the printer automatically.
- If many items are set to be printed, printing may not be completed within the interval. If many items are set to print, printing may not be completed within the interval. In this case, the interval data outputted when the buffer memory (about 28KB) of the printer is full is not printed.

## 8.4 Copying a Screen to the Printer

SET UP



Press the **SET UP** key to display the setting screen.  
Set the printer.

❖8.2 Setting the Printer (page 144)

F5

NEXT  
SCR

Press the **F5** (NEXT SCR) key to display the data-output setting screen.

SET UP	2/5 DATA OUTPUT	2002/07/24
		20:01:47
MEAS. START	MANUAL	
MEAS. STOP	MANUAL	
INTERVAL TIME	1 min	
SAVE IN...	PC CARD	
DATA FILE NAME		
RS CONNECTION	PC	
DISPLAY COPY	PC CARD	
MANUAL	TIME	JUST
		NEXT SCR

Move the cursor to "**DISPLAY COPY.**"

F3

PRINTER

Press the **F3** (PRINTER) key.

❖5.3.7 Setting the Medium to which the Screen is to be Copied (page 82)

Display a screen  
to be copied.

COPY



Press the **COPY** key to print out the screen currently on display.

# Using the Instrument with a Computer

## 9

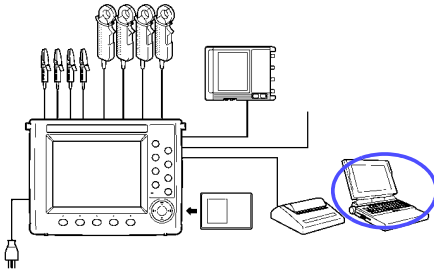

The 3169-20/21 includes an RS-232C interface as standard equipment. Using the RS-232C interface, settings of the 3169-20/21 can be made and measurement data can be acquired on a PC. This chapter explains how to connect the 3169-20/21 to a PC. For details including communications commands, see the RS-232C instruction manual (CD-R version).

### NOTE

For communications using the RS-232C interface, the optional 9612 RS-232C cable is required.

## 9.1 RS-232C Connection

### WARNING

- To avoid electric shock, always remove the power cord from the instrument and disconnect any test leads before connecting the RS-232C cable to the instrument.
- The instrument and modem should be turned off before connecting them.
- Do not connect or disconnect the cable with power on. Otherwise, the devices could be damaged.

### CAUTION

Align the 9612 RS-232C cable with the connector of the 3169-20/21, and insert the cable straight in. To prevent damage and contact failure, do not exert excessive force on the cable.

### NOTE

- Always tighten the screws when connecting the RS-232C cable.
- If the connector of the PC is not a D-sub9-pin connector, use a commercially available conversion adapter.

## Connection to the PC to the 3169-20/21

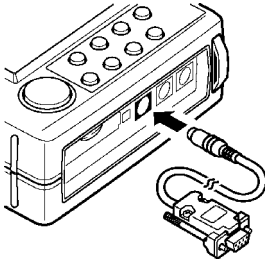

9612 RS-232C CABLE  
(cross cable)

To connect the 3169-20/21 to a PC, you need the optional 9612 RS-232C cable. The 9612 RS-232C cable is a cross cable.

1. Turn off the power to the 3169-20/21 and the PC.
2. Using the 9612 RS-232C cable, connect the RS-232C connectors of the 3169-20/21 to the PC.

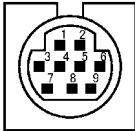

RS-232C  
connector

Pin	Functions	CCITT	EIA	JIS	Signal Name
		Circuit No.	Code Addr.	Code Addr.	
2	Receive Data	104	BB	RD	RxD
3	Send Data	103	BA	SD	TxD
5	Signal Ground	102	AB	SG	GND
7	Request to Send	105	CA	RS	RTS
8	Clear to Send	106	CB	CS	CTS

## 9.2 Setting the RS-232C

Set the RS-232C. For communications between the 3169-20/21 and the PC, the 3169-20/21 must have the same RS-232C settings as those of the PC.

SET UP



Press the **SET UP** key to display the setting screen.



**NEXT  
SCR**

Press the **F5** (NEXT SCR) key to display the data-output setting screen.

SET UP 2/5 DATA OUTPUT	2002/07/24 20:01:47
MEAS. START	MANUAL
MEAS. STOP	MANUAL
INTERVAL TIME	1 min
SAVE IN..	PC CARD
DATA FILE NAME	
RS CONNECTION	PC
DISPLAY COPY	PC CARD
MANUAL TIME	JUST
	NEXT SCR

Move the cursor to "**RS CONNECTION.**"



**PC**

Press the **F1** (PC) key to set the device to be connected to the RS-232C to PC.



**F5** NEXT  
SCR

Press the **F5** (NEXT SCR) key to display the system setting screen.

SET UP 4/5 SYSTEM		2002/07/24 19:23:55
THD	THD-F	
HARM. DISP. ORD.	ALL ORDERS	
RS-232C		
BAUD RATE	9600bps	
TERMINATOR	CR+LF	
FLOW CONTROL	NONE	
BACKLIGHT	AUTO	
BEEP SOUND	ON	
ID	001	
TIME AND DATE	2002/07/24 19:22:56	
LANGUAGE	ENGLISH	
SERIAL NUMBER	020437412 Ver. 1.02	
THD-F	THD-R	NEXT SCR



Move the cursor to an RS-232C setting item to be changed. Set the RS-232C setting items.

Setting Item	Presets
BAUD RATE	2400, 9600, 19200, 38400 bps
TERMINATOR	CR+LF, CR
FLOW CONTROL	OFF, XON/XOFF, RTS/CTS, Both

## NOTE

- In the event of an over-run error or framing error, select a lower baud rate.
- Do not edit the settings during communications with the 3169-20/21.
  - ❖ 5.5.3 Setting the RS-232C (page 92)



# Using the External Input/Output Terminal

## 10

The external input/output terminal uses 0/5-V logic signals or short/open contact signals to control the 3169-20/21. For connection, the optional 9440 cable is required.

## 10.1 Connecting the External Input/Output Terminal

### Connecting the External Input/Output Terminal

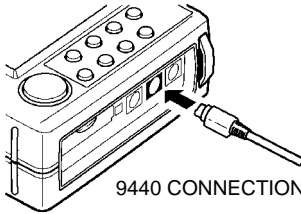

9440 CONNECTION CABLE

Insert the 9440 connection cable into the external input/output terminal (EXT I/O), aligning the connector guide grooves (the connector is equipped with a lock). When removing the connection cable, hold it by the plastic part.

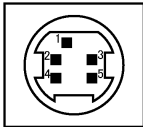

External input/output connector (EXT I/O)

Pin No.	Signal Name	9440 Cable Color
1	Start/stop (input)	Red
2	--	White
3	Status (output)	Black
4	Data storage (input)	Yellow
5	Ground (common)	Blue

### NOTE

A plastic connector is used for the connection cable. Do not insert it into the terminal without aligning the guide grooves or pull it without releasing the lock, to prevent damage to the connector.

## 10.2 Functions of the External Input/Output Terminal

### CAUTION

To prevent damage to the 3169-20/21, do not input to the input terminal a voltage beyond the range -0.5 V to +5.5 V.

### NOTE

- The external I/O functions will not operate properly if a signal with noise or chattering is input.
- The external I/O functions are enabled even when the keys are locked.

### Input Terminal

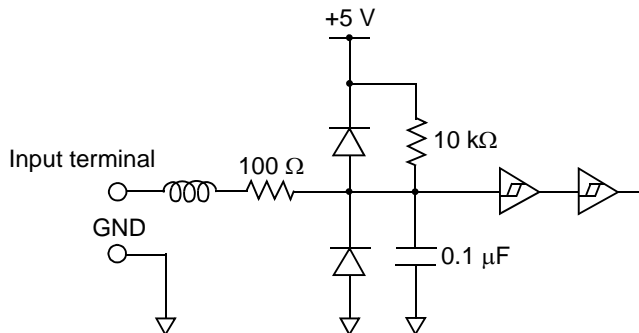

An 0/5-V logic signal or short/open contact signal is used for control.

**(1) Start/Stop of Time-Series Measurement**

Open (High level) → Short (low level): Starts measurement  
 Short (Low level) → Open (high level): Stops measurement

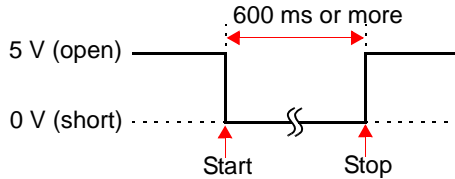
**NOTE**

There is lag of approximately 600 ms from when the measurement start signal is input until the 3169-20/21 starts measurement.

**(2) Data Storage into the Selected Medium**

Saves measurement data manually on the PC card or in the internal memory, whichever is selected as the medium for saving data  
 Short (low level): Manual storage

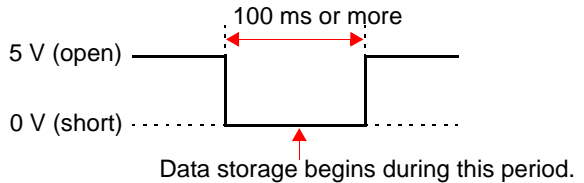

Input-voltage range: High level: 2.5 V to 5.0 V

Low level: 0 V to 1.0 V

Maximum input voltage: -0.5 to 5.5 V

**NOTE**

- This function is disabled during time-series measurement.
- The function does not operate properly if the pulse is less than 100 ms.

## Output terminal

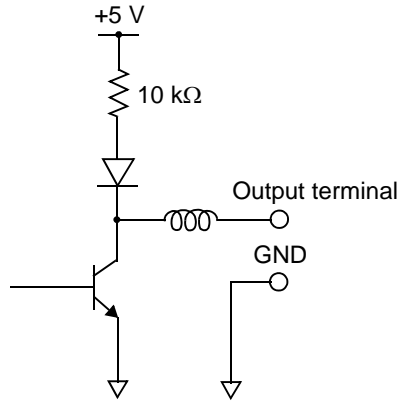

### Status Output

Outputs a status signal indicating that the 3169-20/21 is performing time-series measurement.

During time-series measurement: Short (low level)

Status other than time-series measurement: Open (high level)

### NOTE

- When the 3169-20/21 is standing by for measurement, it is treated as status other than time-series measurement.
- The lag of a signal is approximately 600 ms.

Output signal: Open-collector output (with voltage output)

Output-voltage range: High level: 4.5 V to 5.0 V  
Low level: 0 V to 0.5 V

Maximum input voltage: 0 to 30 V, 50 mAmax., 200 mWmax.

## 10.3 Controlling Multiple Units of the 3169-20/21

When using multiple units of the 3169-20/21, their start/stop of time-series measurement may be synchronized using the external I/O terminal.

### Control Parallel

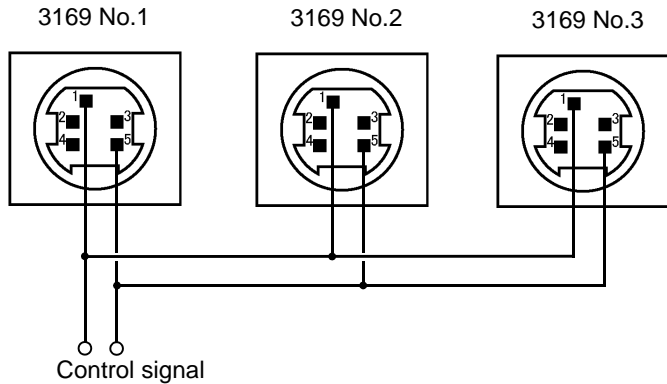

### Master-Slave Connection

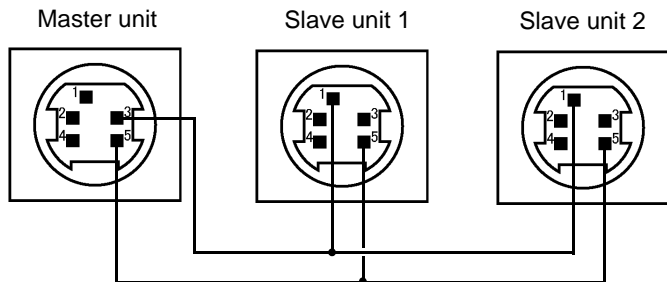

The slave units start time-series measurement, synchronized with the time-series measurement start signal output from the master unit.





# Using D/A Output (3169-21 only)

# 11

When the D/A output function is used, measurement data such as the voltage, current, and power is output in analog (D/A) form.

## 11.1 Connecting the D/A Output Terminal

### WARNING

To avoid electrocution, turn off the power to all devices before plugging or unplugging any of the D/A output connectors.

### CAUTION

- To prevent damage to the instrument, never connect or disconnect the connector with the power on (the D/A output is insulated from the voltage input and current input).
- Four output channels are available. Exercise great care when handling, as these channels are not insulated from each other.
- Use the optional 9441 connection cable.
- To prevent damage to the 3169-20/21, do not short-circuit the output terminal or input a voltage.

## Connection to the D/A Output Terminal

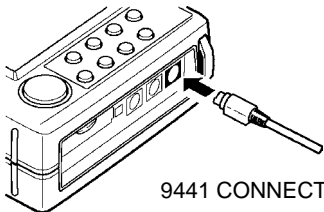

9441 CONNECTION CABLE

Insert the 9441 CONNECTION CABLE into the D/A output terminal, aligning the connector guide grooves (the connector is equipped with a lock). When removing the connection cable, hold it by its plastic part.

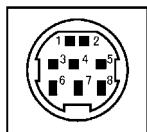
D/A output connector  
(D/A OUT)

Pin No.	Signal Name	9441 Cable Color
1	D/A output ch1	Red
2	D/A output ch2	White
3	D/A output ch3	Black
4	D/A output ch4	Yellow
5	Ground	Blue
6	Ground	Green
7	Ground	Brown
8	Ground	Gray

### NOTE

- Pins 5 to 8 are common ground pins.
- A plastic connector is used for the connection cable. To prevent damage to the connector, do not insert it into the terminal without aligning the guide grooves, and do not pull it without releasing the lock.
- The output resistance of the output terminal is approximately 100  $\Omega$ . Make sure a recorder or other device to be connected to the terminal has an input resistance of 100 k $\Omega$  or more.

## 11.2 Setting D/A Output

### 11.2.1 Setting D/A Output Items

SET UP



Press the **SET UP** key to display the setting screen.

F 5

NEXT  
SCR

Press the **F5** (NEXT SCR) key to display the D/A output setting screen. (SET UP 5/5)

SET UP 5/5 D/A OUTPUT		2002/06/25 11:25:35		
D/A OUTPUT ITEMS				
	TYPE	ITEM	ORDER	MAG.
CH1	POWER	U1	--	1
CH2	POWER	I1 _1	--	1
CH3	POWER	P _1	--	1
CH4	POWER	Q _1	--	1
INTEG. OUTPUT RATE			5V/5kWh	
change			NEXT SCR	



Move the cursor to the item to be changed.

F 1

change

Press the **F1** (change) key to display the selection window.



Select an item to be changed out of the selection list\* using the cursor key.

F 1

select

Press the **F1** (select) key.

## \*: Selection List

Type	Item	Order	Magnification
Power	Voltage (U1,U2,U3,Uave) Current (I1,I2,I3,I4,Iave) Power (P,Q,S) Power factor (PF) Frequency (f) Integrated power (WP+,WP-,WQ+,WQ-)	--	1
Harmonic level	Voltage (U1,U2,U3) Current (I1,I2,I3,I4) Power (P)	1 to 40	1,10,100
Harmonic content	Voltage (U1,U2,U3) Current (I1,I2,I3,I4) Power (P)	1 to 40	1,10,100
Harmonic phase angles	Voltage (U1,U2,U3) Current (I1,I2,I3,I4) Power (P)	1 to 40	1
Total value	Voltage (U1,U2,U3) Current (I1,I2,I3,I4) Power (P)	--	1
THD-F or THD-R	Voltage (U1,U2,U3) Current (I1,I2,I3,I4)	--	1

When multiple circuits are measured, the items for each circuit can be set separately. The items will be followed by a circuit No. (for example, I1\_1, I1\_2, P\_1, P\_2).

**NOTE**

- The selectable items vary depending on the wiring method.
- The output rate will be DC±5 Vf.s.
- The full-scale ranges vary depending on the setting of "Magnification" of "Harmonic level."  
5-A Range

Magnification	Full-Scale Output
1	5 A
10	0.5 A
100	0.05 A

- The full-scale output (DC 5 V) varies as shown below, depending on the setting of "Magnification" of "Harmonic content."

Magnification	Full-Scale Output
1	100%
10	10%
100	1%

## 11.2.2 Setting the Integrated Power Output Rate

Set the output rate when integrated power is output from the D/A terminal. The output rate will be DC  $\pm 5$  V with respect to the set full scale of integrated power.

Select an integration output rate using the cursor keys.

SET UP



F5 NEXT SCR



Press the **SET UP** key to display the setting screen.

Press the **F5** (NEXT SCR) key to display the D/A output setting screen. (SET UP 5/5)

SET UP 5/5 D/A OUTPUT		2002/06/25 11:25:41		
D/A OUTPUT ITEMS				
	TYPE	ITEM	ORDER	MAG.
CH1	POWER	U1	--	1
CH2	POWER	I1 _1	--	1
CH3	POWER	P _1	--	1
CH4	POWER	WP+ _1	--	1
INTEG. OUTPUT RATE				<b>5V/5kWh</b>
change				NEXT SCR



Move the cursor to "**INTEG. OUTPUT RATE.**"

F1 change



Press the **F1** (change) key to display the selection window.

5V/1kWh,5V/5kWh (default),5V/10kWh,5V/50kWh,5V/100kWh,  
5V/500kWh,5V/1MWh



Select integration output rate using the cursor key.

F1 select



Press the **F1** (select) key.

## 11.3 Response of Output

The 3169-20/21 continuously performs calculation in every cycle. (However, during harmonic measurement, calculation is performed after every 16 cycles.) D/A output is also updated in this cycle. Therefore, the output reflects even transient changes in input waveforms, such as the inrush current.

### Normal Measurement Data

Output is updated every cycle (50 Hz: approx. 20 msec; 60 Hz: approx. 17 msec).

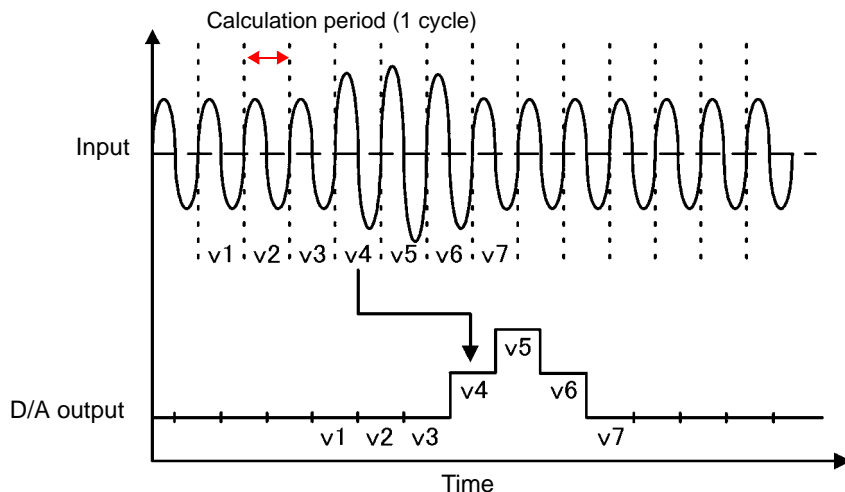

### NOTE

Although the output is updated every cycle, there is a lag of 2 to 3 cycles between the input of a waveform and the D/A output.

## Harmonic Measurement Data

Output is updated every 16 cycles (50 Hz: approx. 320 msec; 60 Hz: approx. 270 msec).

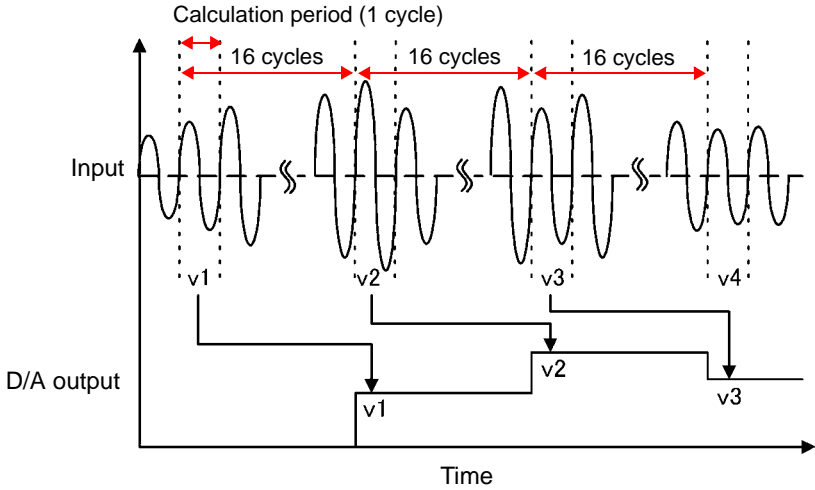

### NOTE

The changed settings for D/A output items become effective when the screen is returned to the measurement screen.

## 11.4 Output Waveform

The format of output waveforms varies depending on the D/A output item. Use the following examples as a guide.

### NOTE

- The output rate will be DC±5 Vf.s.
- In the event of over-range on the plus side, the D/A terminal outputs approximately 6.6 V. In the event of over-range on the minus side, it outputs approximately -6.6 V.
- Please refer to 13.3 Range Configuration and Accuracy by Clamp-On-Sensor (page 188) on f.s. of the power range.
- If the integrated power measurement increases constantly, the output voltage returns to 0 V when it reaches the set full scale, and then the output begins to rise again (the output is recorded as a sawtooth waveform).
- When the VT and CT ratios are set to a number other than 1, the full scale of the range will be the product of the full scale scaling value.
- The D/A output is updated regardless of whether the on-screen measurement data is held.

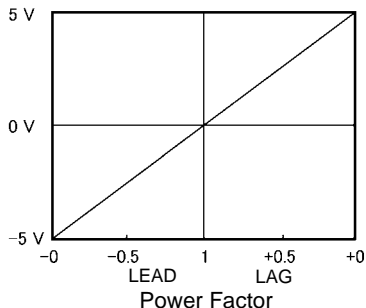
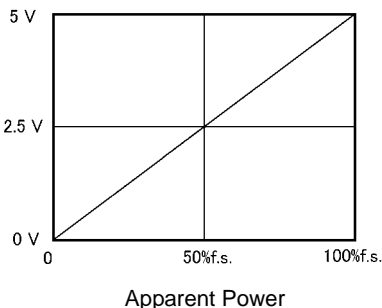
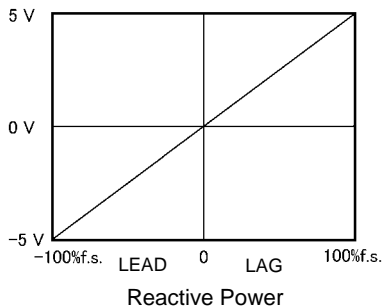
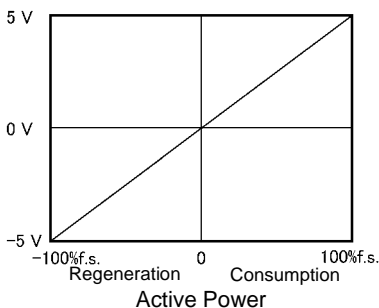



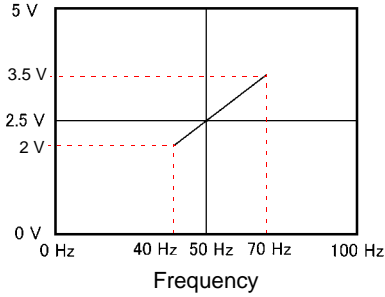

The D/A terminal outputs approximately 6.6V at the frequency other than between 40 and 70 Hz.

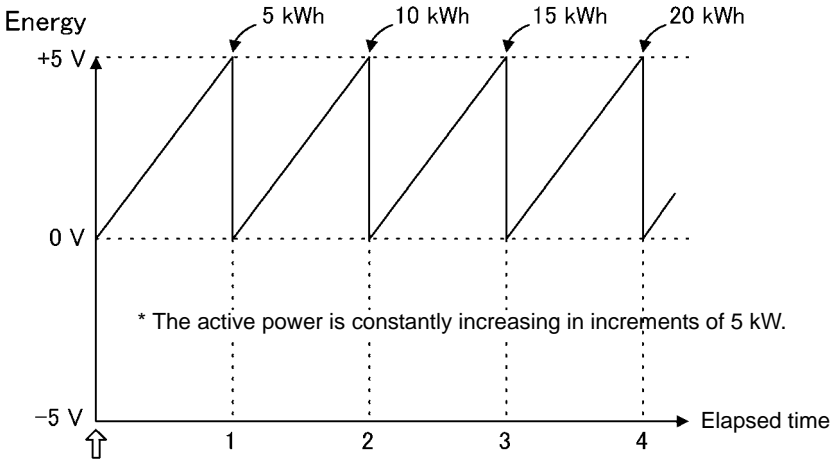

Time-series measurement starts.

\* The unit of kvarh is used for integrated reactive power.

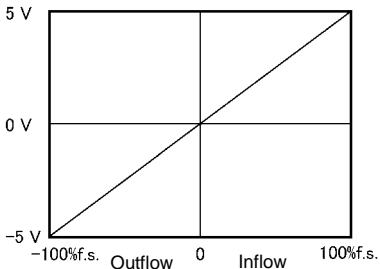

Harmonic Power Level (magnification: 1)

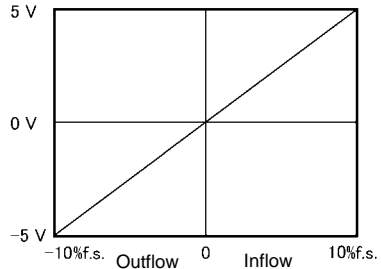

Harmonic Power Level (magnification: 10)

11.4 Output Waveform

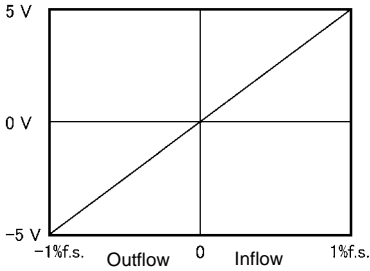

Harmonic Power Level (magnification: 100)

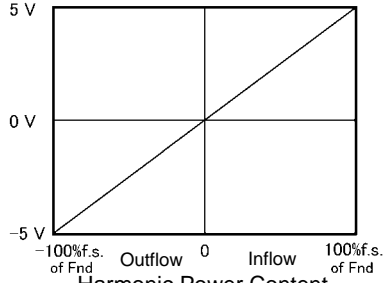

Harmonic Power Content (magnification: 1)

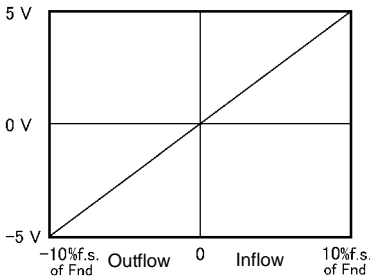

Harmonic Power Percentage Content (magnification: 10)

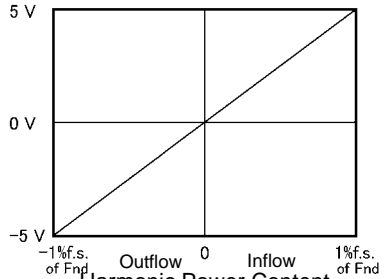

Harmonic Power Content (magnification: 100)

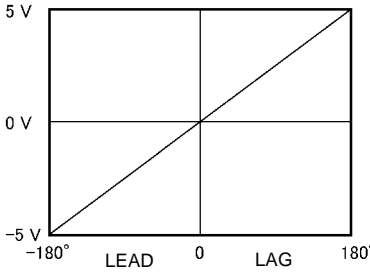

Harmonic Voltage (Current) Phase Angles

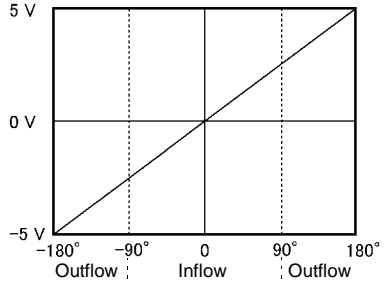

Harmonic Power Phase Angles

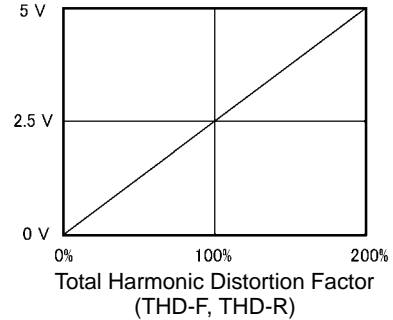
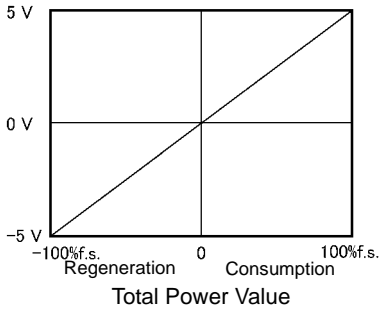
**NOTE**

- The harmonic voltage, the current level, voltage and the current content are not output in negative numbers.
- The harmonic voltage and the current phase angle are based on the phase of the fundamental of the PLL synchronization source,  $U_1$ .
- The phase angle of harmonic power is the power factor of each order of harmonic expressed as an angle.
- The total voltage (current) is not output in negative numbers.



# Operations in the Event of Power Outage

## 12

A power-supply outage of the 3169-20/21 may occur for various reasons during measurement. Such an outage will stop the measurement operation, but the 3169-20/21 has a function for backing up the measurement data and settings made prior to the outage.



### **Clock**

Continues to run



### **Settings**

All settings are retained.



### **Measurement data**

The maximum, minimum, and average values and integrated power measurements taken up to the outage are retained. The demand value at the demand time (i.e., the penultimate time before the outage) is retained. When time-series measurement is performed at a short-term intervals (all wave/100 ms/200 ms/500 ms), the data obtained up until 10 seconds prior to the outage is retained.

## ◆ Operations after Reset

<p>Model 3169-20/ Model 3169-21</p>	<p>Outage during standby state</p> <ul style="list-style-type: none"> <li>• If the instrument is reset before the set time-series measurement start time, the instrument returns to the standby state. It starts time-series measurement at the set start time.</li> <li>• If the instrument is reset after the set time-series measurement start time, the instrument starts time-series measurement at the next interval time.</li> </ul> <p>Outage during time-series measurement</p> <ul style="list-style-type: none"> <li>• The time-series measurement is suspended during the outage. After the instrument is reset, it performs time-series measurement for the remaining time. The measurements during the outage will be treated as "0."</li> </ul>
<p>PC Card/ Internal Memory</p>	<ul style="list-style-type: none"> <li>• If a power outage occurs while the memory is being accessed, the data being saved may be lost or, in the worst case, the file may be broken. If the outage occurs during time-series measurement, the outage time and reset time will be saved after the reset.</li> <li>• If the memory is not accessed during the outage and the outage occurs during time-series measurement, the outage time and reset time will be saved after the reset.</li> </ul>
<p>Printer</p>	<p>If a power outage occurs during printing, the printer stops printing immediately (except when the printer is operating on battery power).</p>

# Specifications

# 13

## 13.1 General Specification

The specifications below apply to the 3169-20/21 CLAMP ON POWER HiTESTER.

### Environmental and Safety Specifications

Operating environment	Indoors, < 2000 m ASL (6562-ft.)
Storage temperature and humidity	-10°C to 50°C (-14°F to 122°F), 80% RH or less (no condensation)
Operating temperature and humidity	0°C to 40°C (32°F to 104°F), 80% RH or less (non-condensing)
Dielectric strength (50/60 Hz for 1 minute)	7.06 kVrms (current sensitivity 1 mA) Between voltage input terminals and instrument case 4.29 kVrms (current sensitivity 1 mA) Between voltage input terminals and current input terminals, between external interface terminals 3 kVrms (current sensitivity 1 mA) Between power supply and instrument case 1.62 kVrms (current sensitivity 10 mA) Between power supply and current input terminals, between external interface terminals
Power supply	Rated power supply voltage: AC100 to 240 V Rated power supply frequency: 50/60 Hz (Voltage fluctuations of $\pm 10\%$ from the rated supply voltage are taken into account.)
Maximum rated power	30 VA
Dimensions	Approx. 210W X 160H X 60D mm (not including protrusions) (8.27"W X 6.30"H X 2.36"D)
Mass	Approx. 1.2 kg (3169-20/21) (42.3 oz.)
Standards applying	Safety EN61010 Pollution Degree 2, Measurement Category III (anticipated transient overvoltage 6000V) EMC EN61326 Class A EN61000-3-2 EN61000-3-3

## Input Specifications

Measurement line type	Single-phase 2-wire (1P2W), single-phase 3-wire (1P3W), three-phase 3-wire (3P3W2M,3P3W3M) or three-phase 4-wire (3P4W,3P4W4I)
Number of circuits to be measured	4 circuits (1P2W), 2 circuits (1P3W,3P3W2M), 1 circuit (3P3W3M,3P4W,3P4W4I) The voltage is the same.
Frequency of the measured line	50/60 Hz
Input methods	Voltage: Isolated inputs (No insulation between U1,U2,U3, and N) Current: input is isolated by the clamp-on sensor
Measurement method	Simultaneous digital sampling of voltage and current PLL synchronization or 50/60-Hz fixed clock
PLL synch channel source	Voltage U1
PLL synch frequency range	45 to 66 Hz
Sampling frequency	128 points/cycle
A/D converter resolution	16 bits
Input resistance (50/60 Hz)	Voltage: $2.0 \text{ M}\Omega \pm 10\%$ (differential operation) Current: $200 \text{ k}\Omega \pm 10\%$
Maximum input voltage	Voltage inputs: AC780 Vrms, 1103 Vpeak Current inputs: AC1.7 Vrms, 2.4 Vpeak
Maximum rated voltage to earth	Voltage input terminals: AC600 Vrms (50/60 Hz)

## Measurement Items

Measurement Items	Voltage, Current, Active power, Reactive power, Apparent power, Power factor, Integrated active power, Integrated reactive power, Frequency, harmonic
-------------------	---

## Display

Display update rate	Approx. 0.5 seconds (Except when the PC card or internal memory is accessed or during RS-232C communications)
Display range	Voltage/current: 0.4% to 130% of the range (zero-suppressed at below 0.4%) Power: 0% to 130% of the range (zero-suppressed when the voltage or current is zero) Harmonic level: 0% to 130% of the range
Effective measurement range	5 to 110% of the range
Display language	Japanese/ English
Display monitor	5.7-inch STN monochrome LCD (320 x 240 dots)
Backlight	Auto OFF/ON/OFF
Contrast	Control using a dial



## Miscellaneous Measurement Items

### Voltage/Current Measurement

Measurement method	True RMS type
Measurement range	Voltage: 150.00/300.00/600.00 V Current: When the 9669 (0.5 mV/A) is used : 100.00/200.00/1.0000k A When the 9661 (1 mV/A) is used : 5.0000/10.000/50.000/ 100.00/500.00 A When the 9660/9695-03 (1 mV/A) is used: 5.0000/10.000/50.000/ 100.00 A When the 9667/CT9667 5000 A range (0.1 mV/A) is used: 5.0000 kA When the 9667/CT9667 500 A range (1 mV/A) is used: 500.00 A When the 9694 (10 mV/A) is used : 500.00 m/1.0000/5.0000 A When the 9695-02 (10 mV/A) is used: 500.00 m/ 1.0000/ 5.0000/ 10.000/ 50.000 A (Selectable separately for each circuit)
Range selection	Manual range (separate current range selectable for each circuit)
Measurement accuracy	Voltage: $\pm 0.2\%$ rdg. $\pm 0.1\%$ f.s. Current: $\pm 0.2\%$ rdg. $\pm 0.1\%$ f.s. + clamp-on-sensor specification
Crest factor	Voltage: 2 or less (for full-scale input) Current: 4 or less (for full-scale input, 2 or less with the 500 A, 1 kA, and 5 kA ranges)

### Active Power Measurement

Measurement range	Depends on the voltage x current range combination.
Measurement accuracy	$\pm 0.2\%$ rdg. $\pm 0.1\%$ f.s.+ clamp-on-sensor specification (power factor = 1)
Power factor influence	$\pm 1.0\%$ rdg. (45 to 66 Hz, power factor = 0.5)
Polarity display	For (consumption) No symbol For (regeneration) "-"

### Reactive Power Measurement

Measurement range	Depends on the voltage x current range combination.
Reactive-power-meter method	Not used: Calculate using the voltage, current, and active-power measurements. Used: Measure the reactive power directly using the reactive-power-meter method.
Measurement accuracy	When the reactive-power-meter method is not used Each calculation result $\pm 1$ dgt. When the reactive-power-meter method is used $\pm 0.2\%$ rdg. $\pm 0.1\%$ f.s. + clamp-on-sensor specification (reactive factor = 1)
Influence of the reactive factor	$\pm 1.0\%$ rdg. (45 Hz to 66 Hz; reactive factor = 0.5; reactive-power-meter method used)
Polarity display	For lag phase (LAG: current is slower than voltage): no symbol For lead phase (LEAD: current is faster than voltage): "-" (Only when the reactive-power-meter method is used)

## Apparent Power Measurement

Measurement range	Depends on the voltage x current range combination.
Measurement accuracy	Each calculation result $\pm 1$ dgt.
Polarity display	No symbol

## Power Factor Measurement

Measurement range	-1.0000 (lead) to 0.0000 to +1.0000 (lag)
Measurement accuracy	$\pm 1$ dgt. for calculations derived from the various measurement values.
Polarity display	For lag phase (LAG: current is slower than voltage): no symbol For lead phase (LEAD: current is faster than voltage): "-" Measurement range

## Frequency Measurement

Measurement method	Reciprocal frequencies
Measurement range	40.000 to 70.000 Hz
Measurement source	Voltage U1 (same as the PLL synchronization source)
Measurement accuracy	$\pm 0.5\%$ rdg. $\pm 1$ dgt. For a sine wave input with a voltage range of 10% to 110%.

## Integrated Power Measurement

Measurement range	Integrated active power Consumption: 0.00000 mWh to 99999.9 GWh Regeneration: -0.00000 mWh to -99999.9 GWh Integrated reactive power Lag: 0.00000 mvarh to 99999.9 Gvarh Lead: -0.00000 mvarh to -99999.9 Gvarh
Measurement accuracy	Measurement accuracy of active power/reactive power $\pm 1$ dgt.
Integration time accuracy	$\pm 10$ ppm $\pm 1$ second (23°C, 73°F)
Measurement display	Integrated active power: Displays consumption/regeneration separately Integrated reactive power: Displays lag/lead separately

## Harmonic Measurement

Measurement range	Fundamental frequency: 45 Hz to 66 Hz
Measurement method	PLL synchronization
Analysis frequencies	Up to the 40th order
Window width	One cycle
Window type	Rectangular
Number of pieces of analysis data	128 points

## Harmonic Measurement

Analysis rate	Once/16 cycles
Analysis item	<p>Harmonic level: Level of each order of harmonic for voltage, current, and power</p> <p>Harmonic content: The content of each order of harmonic for voltage, current, and power</p> <p>Harmonic phase angle: Phase angle of each order of harmonic for voltage, current, and power</p> <p>Total value: Total up to the 40th order harmonics of voltage, current, and power</p> <p>Total THD: Voltage and current (THD-F or THD-R)</p>
Measurement accuracy	<p>Harmonic level</p> <p>1st to 20th orders: <math>\pm 1.0\%rdg. \pm 0.2\%f.s.</math></p> <p>21st to 30th orders: <math>\pm 1.0\%rdg. \pm 0.3\%f.s.</math></p> <p>31st to 40th orders: <math>\pm 2.0\%rdg. \pm 0.3\%f.s.</math></p> <p>For the current and voltage, the clamp-on-sensor specification shall be taken into account.</p> <p>Harmonic power-phase angle</p> <p>The accuracy guarantee range is 1% and over of the range for each order of the harmonic voltage (current) level.</p> <p>1st to 6th orders: <math>\pm 3^\circ</math></p> <p>7th to 40th orders: <math>\pm (0.3^\circ \times k+1^\circ)</math></p> <p>The clamp-on-sensor specification shall be taken into account (k = order of the harmonic).</p>

## Settings

VT (PT) ratio	0.01 to 9999.99
CT ratio	0.01 to 9999.99 (Set separately for each circuit)
Time-series measurement start method	<p>Manual/time setting</p> <p>Time is set as: year (4 digits)/month/day/hour: minute (24-hour clock)</p>
Time-series measurement stop method	<p>Manual/timer/time setting</p> <p>Time is set as: year (4 digits)/month/day/hour: minute (24-hour clock)</p> <p>The timer is set to between 1 second and 8784 hours.</p>
Data-output interval	<p>Standard/short-term</p> <p>The maximum measurement period is one year. Measurement stops immediately after the elapse of that period.</p> <p>When the memory capacity is exceeded, measurement is continued.</p> <p>Performance-assured PC card: 9626,9627,9726,9727,9728 (optional)</p> <p>Standard interval: 1/2/5/10/15/30 seconds 1/2/5/10/15/30/60 minutes</p> <p>The number of output items depends on the interval setting.</p> <p>Short-term interval: 1 cycle/0.1/0.2/0.5 seconds</p> <p>Only instantaneous values are output.</p> <p>Data is saved in the internal buffer memory (no backup function) temporarily, and is then saved in the set medium (PC card/internal memory) every 10 seconds.</p>
Medium for saving data	<p>Memory: PC card/internal memory</p> <p>When the PC card is selected, if it is not installed, data is saved in the internal memory.</p>

## Settings

File name	The file name is set by the user (using up to 8 half-size letters and numbers). If the file name is not set by the user, the instrument sets a file name automatically.
Device to be connected to the RS-232C	PC/printer No output to the printer when the interval is less than 1 minute
THD selection	THD-F (based on the fundamental)/THD-R (based on the fundamental and all harmonics)
Harmonic order for display	All order/odd order
Sampling method	PLL synchronization/fixed clock (50/60 Hz)
Backlight	Auto OFF/ON/OFF Auto OFF turns off the backlight automatically 5 minutes after the last key operation. After the backlight is turned off by Auto OFF, it can be turned on again by pressing any key (the same applies when the keys are locked).
Display average times	OFF/2/5/10/20 (moving average of continuous waveform)
Medium for copying screen	Printer/internal memory/PC card
Beep sound	ON/OFF
Language	Japanese/English/German/Italian/Chinese (Simple, Trad)/French/Spanish/Korean
ID No.	1 to 999
Clock setting	Year (4 digits)/month/day/hour/minute (24-hour clock)

## Other

Life of backup lithium battery	Approx. 6 years (reference data at 23°C, 73°F); for backup of clock and settings (lithium battery)
Clock function	Auto-calendar, automatic leap-year adjustment, 24-hour clock
Clock Accuracy	±10 ppm ±1 second (23°C, 73°F) (within ±1.9 seconds/day (23°C, 73°F))
Internal-memory capacity	1 MB
Frequency characteristics	±3% f.s. + measurement accuracy up to the 50th frequency of the fundamental, with a fundamental frequency of 45 Hz to 66 Hz
Temperature coefficient	Within ±0.03% f.s. / °C
Influence of common-mode voltage	Within ±0.2% f.s. (AC 600 Vrms, 50/60 Hz, between the voltage input terminal (shorted) and the case)
Influence of the external magnetic field	Within ±1.5% f.s. (in a magnetic field of AC 400 Arms/m, 50/60 Hz)
Effect of radiated radio-frequency electromagnetic field	Influence of a radioactive radio-frequency electromagnetic field With a current of ±3% f.s. at 10 V/m (when the 9667 is used; f.s. is the rated primary current of the 9667)

Other

Effect of conducted radio-frequency electromagnetic field	Influence of a conductive radio-frequency electromagnetic field With a current of $\pm 3\%$ f.s. at 3 V (when the 9667 is used; f.s. is the rated primary current of the 9667)
---	---

### Conditions of Guaranteed Accuracy

Conditions of Guaranteed Accuracy	Warmup time of more than 30 minutes, input of a sine wave, power factor = 1, and PLL synchronization
Temperature and humidity for guaranteed accuracy	$23^{\circ}\text{C} \pm 5^{\circ}\text{C}$ ( $73^{\circ}\text{F} \pm 9^{\circ}\text{F}$ ), 80% RH or less
Fundamental waveform range for guaranteed accuracy	45 to 66 Hz
Display area for guaranteed accuracy	Effective measurement area
Period of guaranteed accuracy	1 year

### External Interface Specifications

PC card interface

Slot	PC Card Standard Type II slot x 1
Card	Flash ATA card
Storage capacity	Up to 528 MB
Data format	MS-DOS format
Stored data	Setting, measurement, and screen data

RS-232C interface

Method	EIA RS-232C
Connector	Mini DIN 9-pin connector x 1
Transfer method	Asynchronous communication method, full duplex
Baud rate	2400/ 9600/ 19200/ 38400 bps
Data length	8 bits
Parity check	None
Stop bit	1
Flow control	None, XON/XOFF, RTS/CTS
Delimiter	CR+LF/ CR

## D/A Output (3169-21 only)

Number of output channels	4 channels
Output level	DC $\pm$ 5 V/f.s.
Resolution	Polarity + 11 bits
Output accuracy	Measurement accuracy $\pm$ 0.2% f.s.
Temperature coefficient	$\pm$ 0.02% f.s./ $^{\circ}$ C or less
Output resistance	100 $\Omega$ $\pm$ 5%
Output update rate	Items other than harmonic measurement: Every cycle of measurement input Harmonic measurement items: Every 16 cycles of measurement input
Output items	Selectable from among 4 items Instantaneous value Voltage, current, average voltage, average current, active power, reactive power, apparent power, power factor, frequency Integrated power Integrated active power (consumption/regeneration), Integrated reactive power (lag/lead) Harmonic Harmonic level, harmonic content, and harmonic phase angle of each order; total value; THD-F/THD-R
Integrated power output rate	5 V/1 kWh, 5 V/5 kWh, 5 V/10 kWh, 5 V/50 kWh, 5 V/100 kWh, 5 V/500 kWh, 5 V/1000 kWh
External Input/Output	
Control items	Start/stop of time-series measurement Status output (Low level during time-series measurement) Data storage
Signal level	0/5-V logic signal, short/open contact signal

## Accessories and Options

Accessories	L9438-53 Voltage Cord Power cord Instruction manual (Booklet) Quick start manual (Booklet) RS-232C instruction manual (CD-R) Input cord label 9441 CONNECTION CABLE (3169-21 only)
Options	9660 CLAMP ON SENSOR (100 A rms rating) 9661 CLAMP ON SENSOR (500 A rms rating) 9667 FLEXIBLE CLAMP ON SENSOR (5000 A rms rating) CT9667 FLEXIBLE CLAMP ON SENSOR (5000 A rms rating) 9669 CLAMP ON SENSOR (1000 A rms rating) 9694 CLAMP ON SENSOR (5 A rms rating) 9695-02 CLAMP ON SENSOR (50 Arms rating) 9695-03 CLAMP ON SENSOR (100 Arms rating) 9219 CONNECTION CABLE (for 9695-02/03) 9290-10 CLAMP ON ADAPTER (continuous 1000 A, up to 1500 A, CT ratio 10:1) 9804-01 Magnet Adapter (red one, for changing the voltage cord tips) 9804-02 Magnet Adapter (black one, for changing the voltage cord tips) 9440 CONNECTION CABLE (for external input/output terminal) 9441 CONNECTION CABLE (for D/A output, 3169-21 only) 9612 RS-232C CABLE (for PC) 9442 PRINTER (with 1 roll of thermally sensitized paper supplied, with battery pack) 9443-01 AC ADAPTER (for printers) for Japan 9443-02 AC ADAPTER (for printers) for EU 1196 RECORDING PAPER (25 m, 10 rolls) 9721 RS-232C CABLE (for printer) 9720-01 CARRYING CASE (The voltage cords and clamp-on sensor are also housed in the case.) 9626 PC card 32MB (32 MB compact Flash card + adapter) 9627 PC card 64MB (64 MB compact Flash card + adapter) 9726 PC card 128MB (128 MB compact Flash card + adapter) 9727 PC card 256MB (256 MB compact Flash card + adapter) 9728 PC card 512MB (512 MB compact Flash card + adapter) SF1001 Power Logger Viewer 9625 Power Measurement Support Software

# 13.2 Formulae

## Instantaneous-Value Formulae

Wiring setting	Single-phase 2-wire	Single-phase 3-wire	Three-phase 3-wire		Three-phase 4-wire
Item	1P2W	1P3W	3P3W2M	3P3W3M	3P4W,3P4W4I
Voltage $U$ [Vrms]	$U_1$  $U_i = \sqrt{\frac{1}{M} \sum_{s=0}^{M-1} (U_{is})^2}$	$U_1$ $U_2$  $U_{ave} = \frac{U_1 + U_2}{2}$	$U_1$ $U_2$ $U_3 (U_{3s} = U_{1s} - U_{2s})$ *1  $U_{ave} = \frac{U_1 + U_2 + U_3}{3}$	$U_1 (U_{1s} = u_{1s} - u_{2s})$ $U_2 (U_{2s} = u_{2s} - u_{3s})$ $U_3 (U_{3s} = u_{3s} - u_{1s})$	$U_1$ $U_2$ $U_3$
Current $I$ [Arms]	$I_1$  $I_i = \sqrt{\frac{1}{M} \sum_{s=0}^{M-1} (I_{is})^2}$	$I_1$ $I_2$  $I_{ave} = \frac{I_1 + I_2}{2}$	$I_1$ $I_2$ $I_3 (I_{3s} = -I_{1s} - I_{2s})$ *2  $I_{ave} = \frac{I_1 + I_2 + I_3}{3}$	$I_1$ $I_2$ $I_3$ $I_4$ (3P4W4I only)	
Active power $P$ [W]	$P_1$  $P_i = \frac{1}{M} \sum_{s=0}^{M-1} (U_{is} \times I_{is})$	$P_1 + P_2$		$P_1 + P_2 + P_3$ $U_1$ represents the phase to neutral voltage.	
Reactive power $Q$ [var]	$Q_1$ The reactive-power-meter method is not used. $Q_i = \sqrt{S_i^2 - P_i^2}$ The reactive-power-meter method is used. $Q_i = \frac{1}{M} \sum_{s=0}^{M-1} \left\{ U_{is} \times I_i \left( s + \frac{m}{4} \right) \right\}$	$\sqrt{S^2 - P^2}$  $Q_1 + Q_2$		$Q_1 + Q_2 + Q_3$ $U_1$ represents the phase to neutral voltage.	
Apparent power $S$ [VA]	$S_1$ The reactive-power-meter method is not used. $S_i = U_i \times I_i$ The reactive-power-meter method is used. $S_i = \sqrt{P_i^2 + Q_i^2}$	$S_1 + S_2$	$\frac{\sqrt{3}}{3} (S_1 + S_2 + S_3)$ $U_i$ represents the line to line voltage.	$\frac{\sqrt{3}}{3} (S_1 + S_2 + S_3)$ $U_i$ represents the line to line voltage.	$S_1 + S_2 + S_3$ $U_i$ represents the phase to neutral voltage.
Power factor $PF$	$PF = s_i \left  \frac{P}{S} \right $				

\*1: Provided that  $U_{1s} + U_{2s} + U_{3s} = 0$ \*2: Provided that  $I_{1s} + I_{2s} + I_{3s} = 0$



## NOTE

- $U$ : Line to line voltage (phase to neutral voltage for a three-phase 4-wire line);  $I$ : Line to line current;  $U_{ave}/I_{ave}$ : Average voltage/average current within the circuit;  $s_i$ : Polarity of lead/lag (detected by the reactive-power-meter method, no indication for lag, or a minus sign indicated for lead);  $u$ : Phase voltage from a virtual neutral point;  $i$ : Measurement channel;  $M$ : Number of samples;  $s$ : Sample point No.;  $m$ : Number of samples in a cycle (128)
- The power flow direction is indicated using the polarity signs for active power  $P$ : "+" indicates consumption and "-" indicates regeneration.
- If  $S < |P|$  due to a measurement error, unbalance, or other factor, the 3169-20/21 will process data such that  $S = |P|$ ,  $Q = 0$ , and PF = 1.
- If  $S = 0$ , the instrument processes the data such that PF = over.

## Basic Formulae for Harmonic

Processing Item	kth harmonic		Total up to the 40th	
	Voltage $U$ [Vrms]	$U_k$	$\sqrt{U_{kr}^2 + U_{ki}^2}$	$U_K$
Voltage phase angles $\phi U$ [deg]	$\phi U_k$	$\tan^{-1}\left(\frac{U_{kr}}{-U_{ki}}\right)$ *1	--	--
Current $I$ [Arms]	$I_k$	$\sqrt{I_{kr}^2 + I_{ki}^2}$	$I_K$	$\sqrt{\sum_{k=1}^{40} (I_k)^2}$
Current phase angles $\phi I$ [deg]	$\phi I_k$	$\tan^{-1}\left(\frac{I_{kr}}{-I_{ki}}\right)$ *1	--	--
Power $P$ [W]	$P_k$	$U_{kr} \times I_{kr} + U_{ki} \times I_{ki}$	$P_K$	$\sum_{k=1}^{40} P_k$
Reactive power $Q$ [var] *3	$Q_k$	The reactive-power-meter method is used. $U_{kr} \times I_{ki} - U_{ki} \times I_{kr}$ *2	The reactive-power-meter method is not used. $\sqrt{S_k^2 - P_k^2}$	--
Apparent power $S$ [VA] *3	$S_k$	$\sqrt{P_k^2 + Q_k^2}$	$U_k \times I_k$	--
Harmonic voltage content [%]	Voltage	$U_k / U_1 \times 100$ (%)	--	--
	Current	$I_k / I_1 \times 100$ (%)	--	--
	Power	$P_k / P_1 \times 100$ (%)	--	--

Processing Item	kth harmonic		Total up to the 40th	
Total harmonic distortion-F THD-F [%]	--	--	THD <sub>UF</sub>	$\frac{\sqrt{\sum_{k=2}^{40} (U_k)^2}}{U_1} \times 100 (\%)$
	--	--	THD <sub>IF</sub>	$\frac{\sqrt{\sum_{k=2}^{40} (I_k)^2}}{I_1} \times 100 (\%)$
Total harmonic distortion-R THD-R [%]	--	--	THD <sub>UR</sub>	$\frac{\sqrt{\sum_{k=2}^{40} (U_k)^2}}{\sqrt{\sum_{k=1}^{40} (U_k)^2}} \times 100 (\%)$
	--	--	THD <sub>IR</sub>	$\frac{\sqrt{\sum_{k=2}^{40} (I_k)^2}}{\sqrt{\sum_{k=1}^{40} (I_k)^2}} \times 100 (\%)$

\*1: The harmonic phase angle is displayed after it is corrected using the phase of the fundamental of the PLL synchronization/frequency source as the reference phase (0.0°). When  $U_{ki} = U_{kr} = 0$ ,  $\phi U_k = 0^\circ$ . When  $I_{ki} = I_{kr} = 0$ ,  $\phi I_k = 0^\circ$ .

\*2: Reactive power is calculated with the phase of the harmonic component of the current lagged by 90 degrees.

\*3: The calculation is performed internally and the result is not displayed on-screen.

**NOTE**

k: Harmonic order ( $k = 1$  to  $40$ ),  $K: K = 40$

r: resistance component after FFT

i: reactance component after FFT

**Harmonic Formulae for Each Connection Method**

Item	Wiring	Single-phase 2-wire	Single-phase 3-wire	Three-phase 3-wire		Three-phase 4-wire
		1P2W	1P3W	3P3W2M	3P3W3M	3P4W,3P4W4I
Voltage $U_k$ [Vrms]		$U_{1k}$	$U_{1k}$ $U_{2k}$	$U_{1k}$ $U_{2k}$ $U_{3k}$ *6	$U_{1k}$ $U_{2k}$ $U_{3k}$ *4	$U_{1k}$ $U_{2k}$ $U_{3k}$
Current $I_k$ [Arms]		$I_{1k}$	$I_{1k}$ $I_{2k}$	$I_{1k}$ $I_{2k}$ $I_{3k}$ *5	$I_{1k}$ $I_{2k}$ $I_{3k}$	$I_{1k}$ $I_{2k}$ $I_{3k}$ $I_{4k}$
Active power $P_k$ [W]		$P_{1k}$	$P_{1k} + P_{2k}$	$P_{1k} + P_{2k}$	$P_{1k} + P_{2k} + P_{3k}$ *3	$P_{1k} + P_{2k} + P_{3k}$
Reactive power $Q_k$ [var] *1		$Q_{1k}$	$Q_{1k} + Q_{2k}$	$Q_{1k} + Q_{2k}$	$Q_{1k} + Q_{2k} + Q_{3k}$ *3	$Q_{1k} + Q_{2k} + Q_{3k}$

Wiring Item	Single-phase 2- wire	Single-phase 3-wire	Three-phase 3-wire		Three-phase 4-wire
	1P2W	1P3W	3P3W2M	3P3W3M	3P4W,3P4W4I
Apparent power $S_k$ [VA] *2	$S_{1k}$	$S_{1k} + S_{2k}$	The reactive-power-meter method is used. $\sqrt{P_k^2 + Q_k^2}$		$S_{1k} + S_{2k} + S_{3k}$
			The reactive-power-meter method is not used. $\frac{\sqrt{3}}{3}(S_{1k} + S_{2k} + S_{3k})$		
Power phase angles $\phi_k$ [deg]	The reactive-power-meter method is used.				
	$\tan^{-1}\left(\frac{Q_k}{P_k}\right)$ *7				
	The reactive-power-meter method is not used.				
	$\cos^{-1}\left(\frac{P_k}{S_k}\right)$ *8				

\*1: The calculation is performed internally, and the result is not displayed on-screen, when the reactive-power-meter method is used. The calculation is not performed when the reactive-power-meter method is not used.

\*2: The calculation is performed internally, and the result is not displayed on-screen.

\*3: The phase voltage from a virtual neutral point is used for calculation of  $P$ ,  $Q$ .

$$P_k = u_{1kr} \cdot I_{1kr} + u_{1ki} \cdot I_{1ki} + u_{2kr} \cdot I_{2kr} + u_{2ki} \cdot I_{2ki} + u_{3kr} \cdot I_{3kr} + u_{3ki} \cdot I_{3ki}$$

$$Q_k = (u_{1kr} \cdot I_{1ki} - u_{1ki} \cdot I_{1kr}) + (u_{2kr} \cdot I_{2ki} - u_{2ki} \cdot I_{2kr}) + (u_{3kr} \cdot I_{3ki} - u_{3ki} \cdot I_{3kr})$$

\*4:  $U_{1s} = u_{1s} - u_{2s}$ ,  $U_{2s} = u_{2s} - u_{3s}$ ,  $U_{3s} = u_{3s} - u_{1s}$

$U$ : Line to line voltage;  $u$ : Phase to neutral voltage from a virtual neutral point

\*5:  $I_{3s} = -I_{1s} - I_{2s}$  (provided that  $I_{1s} + I_{2s} + I_{3s} = 0$ )

\*6:  $U_{3s} = U_{1s} - U_{2s}$  (provided that  $U_{1s} + U_{2s} + U_{3s} = 0$ )

\*7: When  $P_k = Q_k = 0$ ,  $\phi_k = 0^\circ$ .

\*8: When  $S_k = 0$ ,  $\phi_k = 0^\circ$ .

## NOTE

- The subscript numbers represent measurement-channel numbers. ( $k$ : Analysis order)
- The expressions above represent the  $k$ th harmonic. In the expressions for total values,  $k$  is replaced by  $K$ .

## 13.3 Range Configuration and Accuracy by Clamp-On-Sensor

### Power Range Configuration (when the 9660, 9661, or 9695-03 is used)

Voltage	Wiring	Current				
		9661 CLAMP ON SENSOR				
		9660/9695-03 CLAMP ON SENSOR (CAT III 300 V)				
		5.0000 A	10.000 A	50.000 A	100.00 A	500.00 A
150.00 V	1P2W	750.00 W	1.5000 kW	7.5000 kW	15.000 kW	75.000 kW
	1P3W 3P3W2M 3P3W3M	1.5000 kW	3.0000 kW	15.000 kW	30.000 kW	150.00 kW
	3P4W 3P4W4I	2.2500 kW	4.5000 kW	22.500 kW	45.000 kW	225.00 kW
300.00 V	1P2W	1.5000 kW	3.0000 kW	15.000 kW	30.000 kW	150.00 kW
	1P3W 3P3W2M 3P3W3M	3.0000 kW	6.0000 kW	30.000 kW	60.000 kW	300.00 kW
	3P4W 3P4W4I	4.5000 kW	9.0000 kW	45.000 kW	90.000 kW	450.00 kW
600.00 V	1P2W	3.0000 kW	6.0000 kW	30.000 kW	60.000 kW	300.00 kW
	1P3W 3P3W2M 3P3W3M	6.0000 kW	12.000 kW	60.000 kW	120.00 kW	600.00 kW
	3P4W, 3P4W4I	9.0000 kW	18.000 kW	90.000 kW	180.00 kW	900.00 kW

### NOTE

- The range-configuration table shows the full-scale display value of each measurement range.
- Voltage and current measurements are indicated as 0.4% to 130% f.s. of the range. If a measurement is below 0.4% f.s., it will be zero-suppressed.
- Power measurement is indicated as 0% to 130% f.s. of the range. It will be zero-suppressed when the voltage or current is 0.
- The accuracy-guarantee ranges of the 9660/9695-03 and 9661 sensors are 5 A to 100 A and 5 A to 500 A, respectively.
- The range configuration for apparent power ( $S$ ) and reactive power ( $Q$ ) is the same, except that the unit is changed to VA and var, respectively.
- When the VT ratio and CT ratio are set, the ranges will be multiplied by (VT ratio x CT ratio) (when a range falls below 1.0000 mW or exceeds 9.9999 GW, a scaling error occurs and the setting is not accepted).

### Accuracy by Clamp-On Sensor (when the 9660, 9661, or 9695-03 is used)

Range	9660 CLAMP ON SENSOR 9695-03 CLAMP ON SENSOR	9661 CLAMP ON SENSOR
500.00 A		$\pm 0.5\% \text{rdg.} \pm 0.11\% \text{f.s.}$
100.00 A	$\pm 0.5\% \text{rdg.} \pm 0.12\% \text{f.s.}$	$\pm 0.5\% \text{rdg.} \pm 0.15\% \text{f.s.}$
50.000 A	$\pm 0.5\% \text{rdg.} \pm 0.14\% \text{f.s.}$	$\pm 0.5\% \text{rdg.} \pm 0.2\% \text{f.s.}$
10.000 A	$\pm 0.5\% \text{rdg.} \pm 0.3\% \text{f.s.}$	$\pm 0.5\% \text{rdg.} \pm 0.6\% \text{f.s.}$
5.0000 A	$\pm 0.5\% \text{rdg.} \pm 0.5\% \text{f.s.}$	$\pm 0.5\% \text{rdg.} \pm 1.1\% \text{f.s.}$

## Power Range Configuration (when the 9669 is used)

Voltage	Wiring	Current		
		9669 CLAMP ON SENSOR		
		100.00 A	200.00 A	1.0000 kA
150.00 V	1P2W	15.000 kW	30.000 kW	150.00 kW
	1P3W 3P3W2M 3P3W3M	30.000 kW	60.000 kW	300.00 kW
	3P4W 3P4W4I	45.000 kW	90.000 kW	450.00 kW
300.00 V	1P2W	30.000 kW	60.000 kW	300.00 kW
	1P3W 3P3W2M 3P3W3M	60.000 kW	120.00 kW	600.00 kW
	3P4W 3P4W4I	90.000 kW	180.00 kW	900.00 kW
600.00 V	1P2W	60.000 kW	120.00 kW	600.00 kW
	1P3W 3P3W2M 3P3W3M	120.00 kW	240.00 kW	1.2000 MW
	3P4W 3P4W4I	180.00 kW	360.00 kW	1.8000 MW

### NOTE

- The range-configuration table shows the full-scale display value of each measurement range.
- Voltage and current measurements are indicated as 0.4% to 130% f.s. of the range. If a measurement is below 0.4% f.s., it will be zero-suppressed.
- Power measurement is indicated as 0% to 130% f.s. of the range. It will be zero-suppressed when the voltage or current is 0.
- The range configuration for apparent power ( $S$ ) and reactive power ( $Q$ ) is the same, except that the unit is changed to VA and var, respectively.
- When the VT ratio and CT ratio are set, the ranges will be multiplied by (VT ratio x CT ratio) (when a range falls below 1.0000 mW or exceeds 9.9999 GW, a scaling error occurs and the setting is not accepted).

## Accuracy by Clamp-On Sensor (when the 9669 is used)

Range	9669 CLAMP ON SENSOR
1.0000 kA	$\pm 1.2\% \text{rdg.} \pm 0.11\% \text{f.s.}$
200.00 A	$\pm 1.2\% \text{rdg.} \pm 0.15\% \text{f.s.}$
100.00 A	$\pm 1.2\% \text{rdg.} \pm 0.2\% \text{f.s.}$

## Power Range Configuration (when the 9667 or the CT9667 is used)

Voltage	Wiring	Current	
		9667/CT9667 FLEXIBLE CLAMP ON SENSOR	
		500 A range	5000 A range
		500.00 A	5.0000 kA
150.00 V	1P2W	75.000 kW	750.00 kW
	1P3W 3P3W2M 3P3W3M	150.00 kW	1.5000 MW
	3P4W 3P4W4I	225.00 kW	2.2500 MW
300.00 V	1P2W	150.00 kW	1.5000 MW
	1P3W 3P3W2M 3P3W3M	300.00 kW	3.0000 MW
	3P4W 3P4W4I	450.00 kW	4.5000 MW
600.00 V	1P2W	300.00 kW	3.0000 MW
	1P3W 3P3W2M 3P3W3M	600.00 kW	6.0000 MW
	3P4W 3P4W4I	900.00 kW	9.0000 MW

### NOTE

- The range-configuration table shows the full-scale display value of each measurement range.
- Voltage and current measurements are indicated as 0.4% to 130% f.s. of the range. If a measurement is below 0.4% f.s., it will be zero-suppressed.
- Power measurement is indicated as 0% to 130% f.s. of the range. It will be zero-suppressed when the voltage or current is 0.
- The range configuration for apparent power (S) and reactive power (Q) is the same, except that the unit is changed to VA and var, respectively.
- When the VT ratio and CT ratio are set, the ranges will be multiplied by (VT ratio x CT ratio) (when a range falls below 1.0000 mW or exceeds 9.9999 GW, a scaling error occurs and the setting is not accepted).

## Accuracy by Clamp-On Sensor (when the 9667 or the CT9667 is used)

Range	9667/CT9667 FLEXIBLE CLAMP ON SENSOR 5000 A range	9667/CT9667 FLEXIBLE CLAMP ON SENSOR 500 A range
5.0000 kA	$\pm 2.2\% \text{rdg.} \pm 0.4\% \text{f.s.}$	
500.00 A		$\pm 2.2\% \text{rdg.} \pm 0.4\% \text{f.s.}$

## Power Range Configuration (when the 9694 or 9695-02 is used)

Voltage	Wiring	Current				
		9695-02 CLAMP ON SENSOR (CAT III 300 V)				
		9694 CLAMP ON SENSOR (CAT III 300 V)			10.000 A	50.000 A
		500.00 mA	1.0000 A	5.0000 A		
150.00 V	1P2W	75.000 W	150.00 W	750.00 W	1.5000 kW	7.5000 kW
	1P3W 3P3W2M 3P3W3M	150.00 W	300.00 W	1.5000 kW	3.0000 kW	15.000 kW
	3P4W 3P4W4I	225.00 W	450.00 W	2.2500 kW	4.5000 kW	22.500 kW
300.00 V	1P2W	150.00 W	300.00 W	1.5000 kW	3.0000 kW	15.000 kW
	1P3W 3P3W2M 3P3W3M	300.00 W	600.00 W	3.0000 kW	6.0000 kW	30.000 kW
	3P4W 3P4W4I	450.00 W	900.00 W	4.5000 kW	9.0000 kW	45.000 kW
600.00 V	1P2W	300.00 W	600.00 W	3.0000 kW	6.0000 kW	30.000 kW
	1P3W 3P3W2M 3P3W3M	600.00 W	1.2000 kW	6.0000 kW	12.000 kW	60.000 kW
	3P4W 3P4W4I	900.00 W	1.8000 kW	9.0000 kW	18.000 kW	90.000 kW

### NOTE

- The range-configuration table shows the full-scale display value of each measurement range.
- Voltage and current measurements are indicated as 0.4% to 130% f.s. of the range. If a measurement is below 0.4% f.s., it will be zero-suppressed.
- Power measurement is indicated as 0% to 130% f.s. of the range. It will be zero-suppressed when the voltage or current is 0.
- The range configuration for apparent power (S) and reactive power (Q) is the same, except that the unit is changed to VA and var, respectively.
- When the VT ratio and CT ratio are set, the ranges will be multiplied by (VT ratio x CT ratio) (when a range falls below 1.0000 mW or exceeds 9.9999 GW, a scaling error occurs and the setting is not accepted).
- The accuracy-guarantee ranges of the 9694 and 9695-02 sensors are 500 mA to 5 A, respectively.

## Accuracy by Clamp-On Sensor (when the 9694 or 9695-02 is used)

Range	9694 CLAMP ON SENSOR	9695-02 CLAMP ON SENSOR
50.000 A	--	± 0.5%rdg. ± 0.12%f.s.
10.000 A	--	± 0.5%rdg. ± 0.2%f.s.
5.0000A	± 0.5%rdg. ± 0.12%f.s.	± 0.5%rdg. ± 0.3%f.s.
1.0000A	± 0.5%rdg. ± 0.2%f.s.	± 0.5%rdg. ± 1.1%f.s.
500.00mA	± 0.5%rdg. ± 0.3%f.s.	± 0.5%rdg. ± 2.1%f.s.





# Maintenance and Service

# 14

## 14.1 Cleaning and Storage

### Cleaning

#### CAUTION

- To clean the product, wipe it gently with a soft cloth moistened with water or mild detergent. Never use solvents such as benzene, alcohol, acetone, ether, ketones, thinners or gasoline, as they can deform and discolor the case.
- Wipe the LCD gently with a soft, dry cloth.
- Measurements are degraded by dirt on the mating surfaces of the clamp-on sensor, so keep the surfaces clean by gently wiping with a soft cloth.

### Storage

- Storage temperature and humidity should be kept between -20 and 50°C, at less than 80% RH.
- Do not store or use the product where it could be exposed to direct sunlight, high temperature or humidity, or condensation. Under such conditions, the product may be damaged and insulation may deteriorate so that it no longer meets specifications.
- When storing the instrument for a long time (one year or more), the specifications are no longer guaranteed. Therefore, before use, have the instrument recalibrated.

## 14.2 Repair and Servicing

### CAUTION

- Adjustments and repairs should be made only by technically qualified personnel.
- If damage is suspected, check the "Troubleshooting" section before contacting your dealer or Hioki representative.
- Pack the product carefully so that it will not be damaged during shipment, and include a detailed written description of the problem. Hioki cannot be responsible for damage that occurs during shipment.

### Calibrations

#### **IMPORTANT**

Periodic calibration is necessary in order to ensure that the instrument provides correct measurement results of the specified accuracy.

The calibration frequency varies depending on the status of the instrument or installation environment. We recommend that the calibration frequency is determined in accordance with the status of the instrument or installation environment and that you request that calibration be performed periodically.

## Troubleshooting

If problems are encountered with operation, check the appropriate items below.

Symptom	Check Items
The POWER LED lights, but the screen is blank.	<ul style="list-style-type: none"> <li>• Is the Power switch turned on?</li> <li>• Are the AC Adapter and power cord securely connected?</li> <li>• Is the LCD Auto Off setting enabled?</li> </ul>
Keys do not operate.	<ul style="list-style-type: none"> <li>• Is a key stuck?</li> <li>• Is the Key Lock switch on?</li> </ul>
Measurements are unstable	<ul style="list-style-type: none"> <li>• Is the line frequency 50 or 60 Hz? 400-Hz line measurements are not supported.</li> </ul>
Measurement data cannot be acquired as intended.	<ul style="list-style-type: none"> <li>• Are the voltage cords and clamp sensors connected properly?</li> <li>• Do the actual measurement lines match the measurement line settings?</li> </ul>
Data cannot be saved to a PC Card.	<ul style="list-style-type: none"> <li>• Is the PC Card firmly inserted?</li> <li>• Is the PC Card initialized (formatted)?</li> <li>• Is the PC Card already full?</li> </ul>
Operation is incorrect when connected to a PC.	<ul style="list-style-type: none"> <li>• Is the instrument turned on?</li> <li>• Is the interface cable connected properly?</li> <li>• Are the interface settings correct?</li> </ul>
Unable to print.	<ul style="list-style-type: none"> <li>• Is the printer turned on?</li> <li>• Is the interface cable connected properly?</li> <li>• Are the interface settings correct?</li> <li>• Is the recording paper loaded properly (front and back)?</li> </ul>
Power does not turn on.	<ul style="list-style-type: none"> <li>• The power protection circuitry may be damaged. As this cannot be replaced or repaired by the user, please contact your supplier or nearest Hioki representative.</li> </ul>

If the cause of the problem still cannot be found, try resetting the system. (page 199) This returns most of the system settings to their factory defaults.

## 14.3 Error Messages

Abnormal behavior	Remedy
<p>When the self-test is executed after turning the power ON, an "NG" judgment is given.</p> <div data-bbox="105 393 435 639" style="border: 1px solid black; padding: 5px;"> <pre> <b>HIOKI 3169</b> -21 CLAMP ON POWER HITESTER  Version 1.00  BACKUPTEST OK FLASH TEST OK DRAM TEST NG SRAM TEST VRAM TEST ADJUST TEST </pre> </div>	<p>The instrument is damaged. Contact your dealer or Hioki representative.</p>
<p>The instrument cannot be started properly and the following message is displayed.</p> <pre> ASSERT:(OFF&lt;=val)&amp;&amp;(val&lt;ON) FILE C:\prog\src3169\001\system.c LINE3507 </pre>	<p>Since the lithium battery in the instrument is worn out, a backup error occurred. The battery life is approximately six years. Execute the system reset to the factory default settings in order to remedy the error message and restore the instrument to proper operation.</p> <p>The procedure is as follows.</p> <p>&lt;How to execute the system reset to the factory default settings&gt;</p> <ol style="list-style-type: none"> <li>1. Turn the power ON while holding the <b>FILE</b> key. Hold the key until you hear a beep.</li> <li>2. Turn the power OFF after the instrument is started.</li> <li>3. Turn on the power ON without pressing the <b>FILE</b> key.</li> </ol> <p>After turning the power ON for the second time, the message, "BACKUP TEST Initializing...", will be displayed. It will take approximately 40 seconds to initialize the internal memory. Leave the instrument until it is started.</p> <p>After the instrument is started, it can be operated properly.</p> <p>If a lithium battery worn-out leads to a backup error, the same error will occur while the instrument is used after a short time. In this case, the battery needs to be replaced. A replacement of the battery cannot be performed by customers. Contact your dealer or Hioki representative.</p>

These messages disappear after a few seconds.

Message	Remedy
During the time-series measurement or waiting mode, this setting cannot be changed.	Change the settings after finishing the time-series measurement.
During the time-series measurement or waiting mode, this function cannot be used.	Change the settings after finishing the time-series measurement.
During the time-series measurement or waiting mode, this operation cannot be performed.	Perform the operation after finishing the time-series measurement.
START TIME has already passed. Start JUST TIME.	Set the start time after the current time.
During HOLD, this setting cannot be changed.	Release HOLD to change settings.

These messages can be cleared by pressing any key.

Message	Remedy
This key cannot be selected during HOLD.	Release HOLD.
If the interval time setting is less than 1 minute, harmonic data output and printer output are not possible.	Set the interval time to 1 minute or longer for harmonic data output and printer output.
Harmonic data output and printer output are not possible.	Set the interval time to 1 minute or longer for harmonic data output and printer output.
Before starting measurement, format the PC CARD.	Format the PC CARD.
The instant value of normal measurement is saved in binary format. Other data is not output.	When a short-term interval is used, the instantaneous values of normal measurement are saved in the binary format.
No PC CARD.	Insert the PC CARD.
PC CARD is not compatible.	Use optional PC CARD of HIOKI.
Write Protected.	Release the write protection of this media.
Max. number of files exceeded.	The number of files exceeds the maximum writable file number. Delete the files, or format the media.
Disk full.	Delete the files, or format the media.
PC CARD is not formatted.	Format the PC CARD.

Message	Remedy
Same name file is already exists.	Rename the file.
Copy failed.	Format the PC CARD or exchange the PC CARD.
Delete failed.	Execute again.
Initializing of internal memory has failed.	Execute again.
Selected file is not a setting file.	Select a setting file.
PC card format failed.	Confirm the PC CARD is properly inserted.
Output to internal memory.	The data is saved in the internal memory, if the PC CARD is selected as a storage media but a PC CARD is not properly inserted, or if the PC CARD is full. Insert the PC CARD properly or exchange the PC CARD.
Data could not be saved to internal memory.	Format the internal memory.
File error.	Format the PC CARD and internal memory, or use the new PC CARD.
Access failed	Format the PC CARD and internal memory, or use the new PC CARD. When formatting the PC CARD on a PC, use the FAT-16 format.
Select a file.	No file is selected. Select a file.
Some files have not been deleted.	The files are broken. Format the PC CARD.
Back up failed.	Format the internal memory.
Scaling error.	Change the VT(PT) or CT ratio setting.

## 14.4 System Reset

1. Turn the power OFF.
2. Turn the power ON again while holding the **SET UP** key. Press and hold the key until you hear a beep.
3. A system reset will return all settings of the 3169-20/21 (except for the clock) to the defaults.

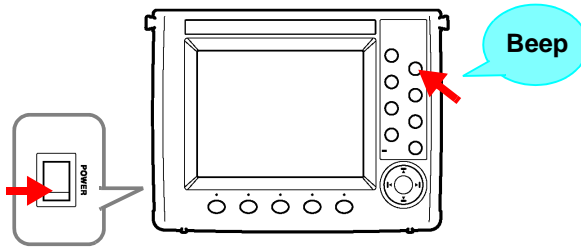

## 14.5 Instrument Disposal

The instrument contains a lithium battery for system backup.

### WARNING

- To avoid electric shock, turn off the power switch and disconnect the power cord before removing the lithium battery.
- Battery may explode if mistreated. Do not short-circuit, recharge, disassemble or dispose of in fire.

### CAUTION

- If the protective functions of the instrument are damaged, either remove it from service or mark it clearly so that others do not use it inadvertently.
- When disposing of this instrument, remove the lithium battery and dispose of battery and instrument in accordance with local regulations.



## Lithium Battery Removal

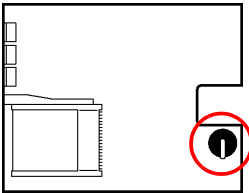
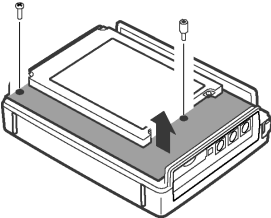
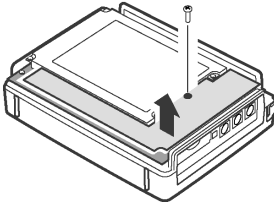
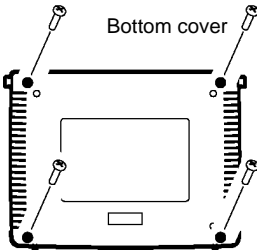

Required tools:

- Phillips screwdriver 1
- Wire cutter 1
- Hexagonal wrench 1

1. Turn OFF the power to the 3169-20/21.
2. Turn the instrument upside down and remove the four screws affixing the bottom cover.
3. Turn the instrument right side up and remove the top cover.
4. Remove one screw, and then remove the key circuit board.
5. Cut the two leads of the button-type lithium battery near the corner of the circuit boards.
6. Remove two screws, and then remove the circuit board fastening the LCD.

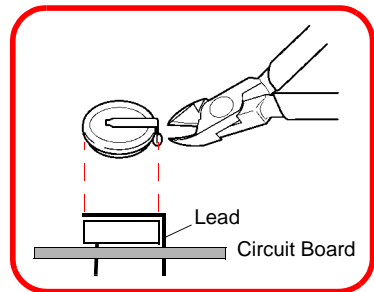

**CALIFORNIA, USA ONLY**

This product contains a CR Coin Lithium Battery which contains Perchlorate Material - special handling may apply. See [www.dtsc.ca.gov/hazardouswaste/perchlorate](http://www.dtsc.ca.gov/hazardouswaste/perchlorate)



# Appendix

## Power Measurement by the 2 Power-Meter Method and $U_3/I_3$ Measurement Theory (3P3W2M mode)

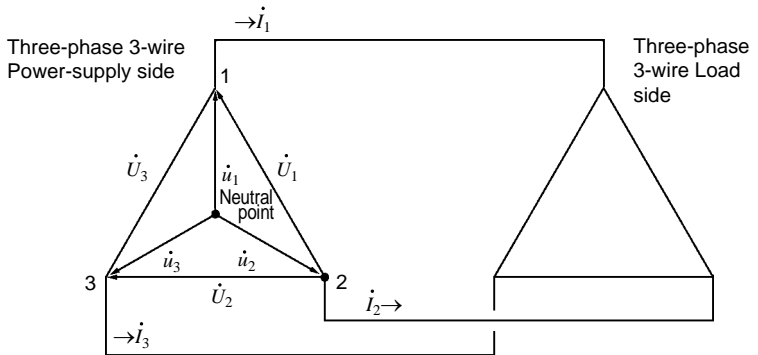

The figure above shows an artificial circuit of a three-phase 3-wire line. In the figure,  $\dot{U}_1$ ,  $\dot{U}_2$ , and  $\dot{U}_3$  represent the vectors of line to line voltage;  $\dot{I}_1$ ,  $\dot{I}_2$ , and  $\dot{I}_3$  represent the line (phase) current vectors;  $\dot{u}_1$ ,  $\dot{u}_2$ , and  $\dot{u}_3$  represent the phase to neutral voltage vectors. Normally, three-phase power  $P$  is obtained as the sum of the power of the phases.

$$P = \dot{u}_1 \dot{I}_1 + \dot{u}_2 \dot{I}_2 + \dot{u}_3 \dot{I}_3 \quad (1)$$

A three-phase 3-wire line, however, doesn't have a neutral point, and the power of each phase cannot be measured directly. If a neutral point hypothetically existed, three power meters must be used simultaneously. For this reason, the 2-power-meter method (2 voltages and 2 currents) using the line voltage is generally used instead. Theoretically, the power of each phase is obtained using the following equation:

If measuring  $\dot{U}_1$ ,  $\dot{U}_2$ ,  $\dot{I}_1$ , and  $\dot{I}_3$  using power meters,

$$\begin{aligned} P &= \dot{U}_1 \dot{I}_1 + \dot{U}_2 \dot{I}_3 && (\dot{U}_1 = \dot{u}_1 - \dot{u}_2, \dot{U}_2 = \dot{u}_3 - \dot{u}_2) \\ &= (\dot{u}_1 - \dot{u}_2) \dot{I}_1 + (\dot{u}_3 - \dot{u}_2) \dot{I}_3 \\ &= \dot{u}_1 \dot{I}_1 + \dot{u}_2 (-\dot{I}_3 - \dot{I}_1) + \dot{u}_3 \dot{I}_3 \quad (\text{because } \dot{I}_1 + \dot{I}_2 + \dot{I}_3 = 0 \text{ provided that} \\ &\quad \text{the circuit is closed}) \\ &= \dot{u}_1 \dot{I}_1 + \dot{u}_2 \dot{I}_2 + \dot{u}_3 \dot{I}_3 \quad (2) \end{aligned}$$

Equation (1) coincides with equation (2). This proves that the power of a three-phase 3-wire line is measured by the 2-power-meter method. In addition, there is no special precondition required, except that the circuit must be closed and without leakage current. Therefore, three-phase power can be obtained regardless of whether the cable way is balanced or unbalanced. The 3P3W2M mode of the 3169-20/21 employs this method. In addition, because the sum of the voltage (current) vectors is always zero, the 3169-20/21 internally implements the following equations to measure the 3rd voltage and current:

$$\begin{aligned} |\dot{U}_3| &= |\dot{U}_1 - \dot{U}_2| \\ |\dot{I}_2| &= |-\dot{I}_1 - \dot{I}_3| \end{aligned}$$

Regarding  $U_3$  and  $I_2$ , measurement is performed regardless of whether distortion is present. These values are reflected in the three-phase apparent power and power factor (when the reactive-power-meter method is not used).

## NOTE

In the 3P3W2M mode of the 3169-20/21, the phase C current of the three-phase line is input to  $I_2$  of each circuit. On the display, the current measurement of phase C is shown as  $I_2$ , and the calculation result of phase B is shown as  $I_3$ .

# Headers of Output Data

## Instantaneous-Value Data (Normal Measurement), Integrated Power and Demand Value

Classification	Data Header	Contents	Unit
Date and Time	DATE	Data-output date, yyyy/m/d	
	TIME	Data-output time, h:mm:ss	
	ETIME	Elapsed time, hhhh:mm:ss	
Information	STATUS	10-bit data showing various pieces of status information	
Voltage	U1_INST[V]	Voltage RMS value, CH1	V
	U2_INST[V]	Voltage RMS value, CH2	V
	U3_INST[V]	Voltage RMS value, CH3	V
	Uave_INST[V]	Voltage RMS value, Average value of channels	V
Current	I1_INST[A]_1 to I1_INST[A]_4	Current RMS value, CH1, Circuit 1-4	A
	I2_INST[A]_1 to I2_INST[A]_2	Current RMS value, CH2, Circuit 1-2	A
	I3_INST[A]_1 to I3_INST[A]_2	Current RMS value, CH3, Circuit 1-2	A
	Iave_INST[A]_1 to Iave_INST[A]_2	Current RMS value, Average value of channels, Circuit 1-2	A
	I4_INST[A]_1	Current RMS value, CH4	A
Power	P_INST[W]_1 to P_INST[W]_4	Active power, Circuit 1-4	W
	Q_INST[var]_1 to Q_INST[var]_4	Reactive power, Circuit 1-4	var
	S_INST[VA]_1 to S_INST[VA]_4	Apparent power, Circuit 1-4	VA
Power Factor	PF_INST_1 to PF_INST_4	Power factor, Circuit 1-4	
Frequency	F_INST[Hz]	Frequency	Hz
Value of each CH	P1_INST[W]_1 to P1_INST[W]_2	Active power, CH1, Circuit 1-2	W
	P2_INST[W]_1 to P2_INST[W]_2	Active power, CH2, Circuit 1-2	W
	P3_INST[W]_1	Active power, CH3	W
	Q1_INST[var]_1 to Q1_INST[var]_2	Reactive power, CH1, Circuit 1-2	var
	Q2_INST[var]_1 to Q2_INST[var]_2	Reactive power, CH2, Circuit 1-2	var
	Q3_INST[var]_1	Reactive power, CH3	var
	S1_INST[VA]_1 to S1_INST[VA]_2	Apparent power, CH1, Circuit 1-2	VA
	S2_INST[VA]_1 to S2_INST[VA]_2	Apparent power, CH2, Circuit 1-2	VA
	S3_INST[VA]_1	Apparent power, CH3	VA
	PF1_INST_1 to PF1_INST_2	Power factor, CH1, Circuit 1 to 2	
	PF2_INST_1 to PF2_INST_2	Power factor, CH2, Circuit 1-2	
	PF3_INST_1	Power factor, CH3	

Classification	Data Header	Contents	Unit
Integrated power	Total integrated power from the start of time-series measurement		
	WP+_INTEG[Wh]_1 to WP+_INTEG[Wh]_4	Integrated active power (consumption), Circuit 1-4	Wh
	WP-_INTEG[Wh]_1 to WP-_INTEG[Wh]_4	Integrated active power (regeneration), Circuit 1-4	Wh
	WQ+_INTEG[varh]_1 to WQ+_INTEG[varh]_4	Integrated reactive power (lag), Circuit 1-4	varh
	WQ-_INTEG[varh]_1 to WQ-_INTEG[varh]_4	Integrated reactive power (lead), Circuit 1-4	varh
Demand	Integrated power within interval		
	WP+_INTVL[Wh]_1 to WP+_INTVL[Wh]_4	Integrated active power (consumption), Circuit 1-4	Wh
	WP-_INTVL[Wh]_1 to WP-_INTVL[Wh]_4	Integrated active power (regeneration), Circuit 1-4	Wh
	WQ+_INTVL[varh]_1 to WQ+_INTVL[varh]_4	Integrated reactive power (lag), Circuit 1-4	varh
	WQ-_INTVL[varh]_1 to WQ-_INTVL[varh]_4	Integrated reactive power (lead), Circuit 1-4	varh
	Average value within interval (demand value)		
	P_DEM[W]_1 to P_DEM[W]_4	Average value within time Active power (Consumption), Circuit 1-4	W
	Q_DEM[var]_1 to Q_DEM[var]_4	Average value within time Reactive power (LAG), Circuit 1-4	var
	PF_DEM_1 to PF_DEM_4	Average value within time Power factor, Circuit 1-4 $\frac{P\_DEM}{\sqrt{P\_DEM^2+Q\_DEM^2}} \quad *1$	
	Maximum demand value during time-series measurement		
P_DEM_MAX[W]_1 to P_DEM_MAX[W]_4	Maximum demand value, Active power, , Circuit 1-4	W	
P_DEM_MAX DATE_1 to P_DEM_MAX DATE_4	Date of occurrence of maximum demand yyyy/m/d , Circuit 1-4		
P_DEM_MAX TIME_1 to P_DEM_MAX TIME_4	Time of occurrence of maximum demand h:mm:ss, Circuit 1-4		

\*1: If the regeneration power has only occurred during the interval, P\_DEM = 0 and PF\_DEM = 1.

**NOTE**

- "INST" in the header will be replaced by "AVE" for the average-value data.
- "INST" in the header will be replaced by "MAX" for the maximum-value data.
- "INST" in the header will be replaced by "MIN" for the minimum-value data.

## Instantaneous-Value Data (Harmonic Measurement)

Classification	Data Header	Contents	Unit
Harmonic Level	U1(n)_INST[V]	nth harmonic voltage (U1) RMS	V
	U2(n)_INST[V]	nth harmonic voltage (U2) RMS	V
	U3(n)_INST[V]	nth harmonic voltage (U3) RMS	V
	I1(n)_INST[A]_1 to I1(n)_INST[A]_4	nth harmonic current (I1) RMS Circuits 1-4	A
	I2(n)_INST[A]_1 to I2(n)_INST[A]_2	nth harmonic current (I2) RMS Circuits 1 to 2	A
	I3(n)_INST[A]_1 to I3(n)_INST[A]_2	nth harmonic current (I3) RMS Circuits 1 to 2	A
	I4(n)_INST[A]_1 P(n)_INST[W]_1 to P(n)_INST[W]_4	nth harmonic current (I4) RMS nth harmonic power Circuits 1 to 4	A W
Harmonic Percentage Content	U1(n)_INST[%]	nth harmonic voltage (U1) Content	%
	U2(n)_INST[%]	nth harmonic voltage (U2) Content	%
	U3(n)_INST[%]	nth harmonic voltage (U3) Content	%
	I1(n)_INST[%]_1 to I1(n)_INST[%]_4	nth harmonic current (I1) Content, Circuits 1 to 4	%
	I2(n)_INST[%]_1 to I2(n)_INST[%]_2	nth harmonic current (I2) Content, Circuit 1-2	%
	I3(n)_INST[%]_1 to I3(n)_INST[%]_2	nth harmonic current (I3) Content Circuit 1-2	%
	I4(n)_INST[%]_1 P(n)_INST[%]_1 to P(n)_INST[%]_4	nth harmonic current (I4) Content nth harmonic power Content Circuits 1 to 4	% %
Harmonic Phase Angles	U1deg(n)_INST[deg]	nth harmonic voltage (U1) Phase angle	deg
	U2deg(n)_INST[deg]	nth harmonic voltage (U2) Phase angle	deg
	U3deg(n)_INST[deg]	nth harmonic voltage (U3) Phase angle	deg
	I1deg(n)_INST[deg]_1 to I1deg(n)_INST[deg]_4	nth harmonic current (I1) Phase angle, Circuits 1 to 4	deg
	I2deg(n)_INST[deg]_1 to I2deg(n)_INST[deg]_2	nth harmonic current (I2) Phase angle, Circuit 1-2	deg
	I3deg(n)_INST[deg]_1 to I3deg(n)_INST[deg]_2	nth harmonic current (I3) Phase angle, Circuit 1-2	deg
	I4deg(n)_INST[deg]_1 Pdeg(n)_INST[deg]_1 to Pdeg(n)_INST[deg]_4	nth harmonic current (I4) Phase angle nth harmonic power Phase angle, Circuits 1 to 4	deg deg

Classification	Data Header	Contents	Unit
Total Value	TOTAL_U1_INST[V]	Total voltage (U1) (1st to 40th)	V
	TOTAL_U2_INST[V]	Total voltage (U2) (1st to 40th)	V
	TOTAL_U3_INST[V]	Total voltage (U3) (1st to 40th)	V
	TOTAL_I1_INST[A]_1 to TOTAL_I1_INST[A]_4	Total current (I1) (1st to 40th), Circuits 1 to 4	A
	TOTAL_I2_INST[A]_1 to TOTAL_I2_INST[A]_2	Total current (I2) (1st to 40th), Circuit 1-2	A
	TOTAL_I3_INST[A]_1 to TOTAL_I3_INST[A]_2	Total current (I3) (1st to 40th), Circuit 1-2	A
	TOTAL_I4_INST[A]_1	Total current (I4) (1st to 40th)	A
	TOTAL_P_INST[W]_1 to TOTAL_P_INST[W]_4	Total power (1st to 40th) Circuits 1 to 4	W
THD-F (Selected)	THDF_U1_INST[%]	Voltage (U1) Total harmonic distortion (THD-F)	%
	THDF_U2_INST[%]	Voltage (U2) Total harmonic distortion (THD-F)	%
	THDF_U3_INST[%]	Voltage (U3) Total harmonic distortion (THD-F)	%
	THDF_I1_INST[%]_1 to THDF_I1_INST[%]_4	Current (I1) Total harmonic distortion (THD-F) Circuits 1 to 4	%
	THDF_I2_INST[%]_1 to THDF_I2_INST[%]_2	Current (I2) Total harmonic distortion (THD-F), Circuit 1-2	%
	THDF_I3_INST[%]_1 to THDF_I3_INST[%]_2	Current (I3) Total harmonic distortion (THD-F), Circuit 1-2	%
	THDF_I4_INST[%]_1	Current (I4) Total harmonic distortion (THD-F)	%
THD-R (Selected)	THDR_U1_INST[%]	Voltage (U1) Total harmonic distortion (THD-R)	%
	THDR_U2_INST[%]	Voltage (U2) Total harmonic distortion (THD-R)	%
	THDR_U3_INST[%]	Voltage (U3) Total harmonic distortion (THD-R)	%
	THDR_I1_INST[%]_1 to THDR_I1_INST[%]_4	Current (I1) Total harmonic distortion (THD-R) Circuits 1 to 4	%
	THDR_I2_INST[%]_1 to THDR_I2_INST[%]_2	Current (I2) Total harmonic distortion (THD-R), Circuit 1-2	%
	THDR_I3_INST[%]_1 to THDR_I3_INST[%]_2	Current (I3) Total harmonic distortion (THD-R), Circuit 1-2	%
	THDR_I4_INST[%]_1	Current (I4) Total harmonic distortion (THD-R)	%

**NOTE**

- "n" represents the harmonic orders (01 to 40).
- Harmonic measurement data is added after normal measurement data.
- "INST" in the header will be replaced by "AVE" for the average-value data.
- "INST" in the header will be replaced by "MAX" for the maximum-value data.
- "INST" in the header will be replaced by "MIN" for the minimum-value data.



## Harmonic Phase Angles

The harmonic voltage phase angle and harmonic current phase angle are the standard for the PLL source phase (for input based on PLL when U1 is selected on this device) fundamental wave component.

The differences in phase of each harmonic order component and the phase of the fundamental wave component is expressed as an angle ( $^{\circ}$ ) and - indicates a LAG, whereas + indicates a LEAD.

The phase angle of harmonic power is expressed by the power factor of each order of harmonic converted into an angle ( $^{\circ}$ ). When the harmonic-power phase angle is between  $-90^{\circ}$  and  $+90^{\circ}$ , the order of harmonic is flowing in toward the load (inflow). When the phase angle is between  $+90^{\circ}$  and  $+180^{\circ}$  or between  $-180^{\circ}$  and  $-90^{\circ}$ , that order of harmonic is flowing out from the load (outflow).

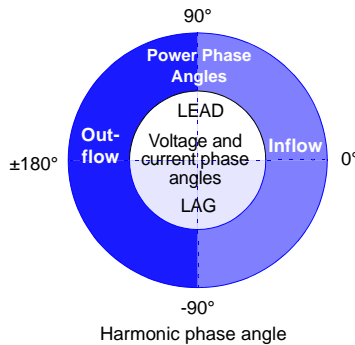

The arithmetic expressions for the harmonic-power phase angle vary depending on whether the reactive-power-meter method is ON or OFF.

**Reactive-Power-Meter Method ON**

Harmonic-power phase angle

$$\phi = \tan^{-1} \frac{Q}{P} [^\circ]$$

Both active power and reactive power have polarities, and the results are expressed by "0° to ±180°". This enables identification of inflow and outflow and lag (-) and lead (+).

**Reactive-Power-Meter Method OFF**

Harmonic-power phase angle

$$\phi = \cos^{-1} \frac{P}{S} [^\circ]$$

Active power has polarities, but apparent power does not. The results are expressed by "0° to +180°". Identification of inflow and outflow is possible, but that of lag (-) and lead (+) is not. Due to the difference in arithmetic expression, the harmonic-power phase angle may differ if the three-phase load is unbalanced.

## Output Data

### How to calculate the average value. (AVE)

The average values of voltage, current, active power, reactive power, apparent power, power factor, and frequency are calculated by the following formulas.

Voltage

$$U\_AVE = \frac{1}{N} \sum_{n=0}^{N-1} U_n$$

The voltage RMS values for every one cycle are averaged within the interval period.

Current

$$I\_AVE = \frac{1}{N} \sum_{n=0}^{N-1} I_n$$

The current RMS values for every one cycle are averaged within the interval period.

Active Power

$$P\_AVE = \frac{1}{N} \sum_{n=0}^{N-1} P_n$$

The active power values for every one cycle are averaged within the interval period. (including the polarity sign)

Reactive Power

$$Q\_AVE = si \frac{1}{N} \sum_{n=0}^{N-1} |Q_n|$$

The absolute values of reactive power for every one cycle are averaged within the interval period.

### NOTE

When the reactive-power-meter method is OFF(not to be used), there is no polarity sign to reactive power value.

Apparent Power

$$S\_AVE = \frac{1}{N} \sum_{n=0}^{N-1} S_n$$

The apparent power values for every one cycle are averaged within the interval period.

### Power Factor

$$PF\_AVE = si \frac{1}{N} \sum_{n=0}^{N-1} |PFn|$$

The absolute values of power factor for every one cycle are averaged within the interval period.

### Frequency

$$F\_AVE = \frac{1}{N} \sum_{n=0}^{N-1} Fn$$

The frequency values for every one cycle are averaged within the interval period.

$N$  : The number of the data in the interval period

$Un$  : The voltage RMS value of every one cycle

$In$  : The current RMS value of every one cycle

$Pn$  : The active power value of every one cycle

$Qn$  : The reactive power value of every one cycle

$Sn$  : The apparent power value of every one cycle

$PFn$  : The power factor value of every one cycle

$Fn$  : The frequency value of every one cycle

$si$  : Polarity of lead or lag (lag: no indication, lead: -)

By assuming when  $Qn \geq 0$ ,  $Q$ ; or when  $Qn < 0$ ,  $Q'$ ;

No indication for  $si$  when  $\Sigma Q \geq \Sigma |Q'|$  in the interval period.

“-“ is indicated for  $si$  when  $\Sigma Q < \Sigma |Q'|$ .

## Data output timing of the instantaneous, average, maximum, and minimum values

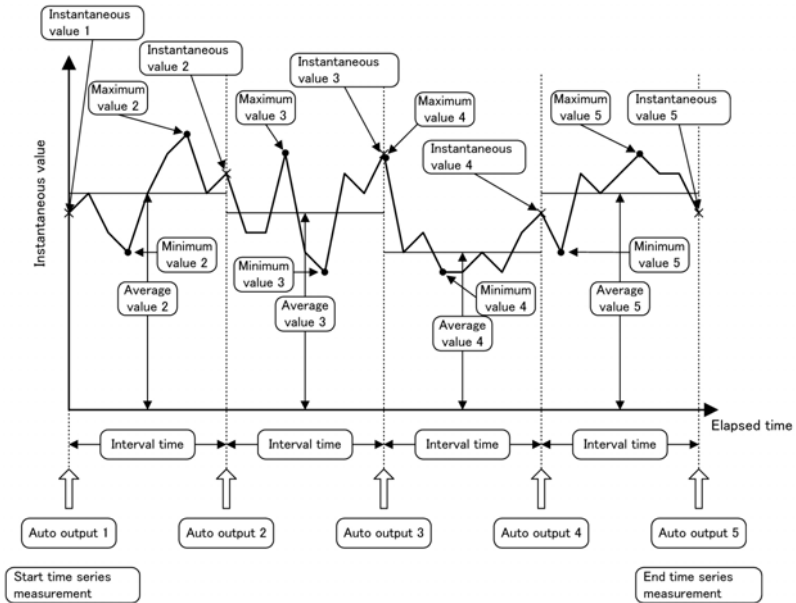

## The maximum and minimum values of active power and reactive power

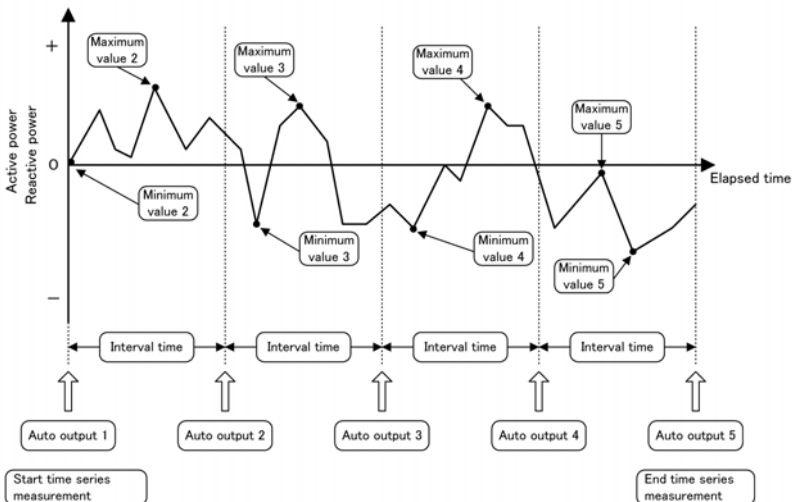

## The maximum and minimum values of power factor

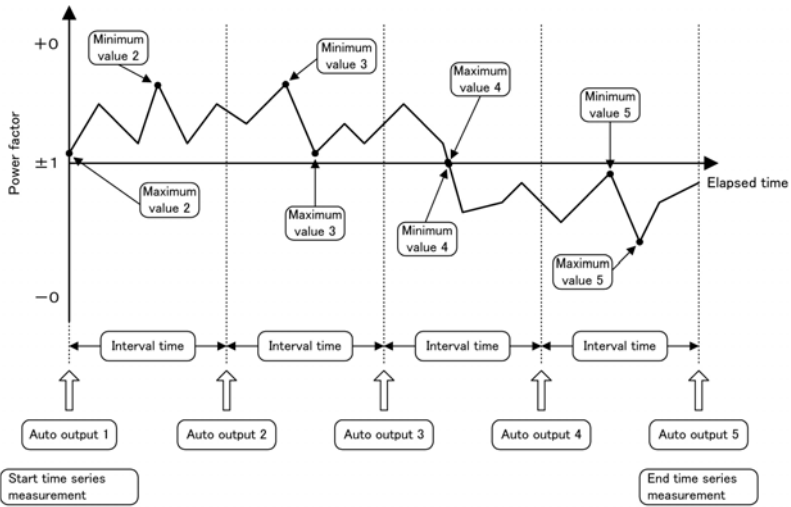

### NOTE

The display shows the average, maximum, and minimum values of the measurements taken up to the current time from the start of time-series measurement.

# Index

## Numerics

---

2-power-meter method ..... 204

## A

---

Accuracy by Clamp-On Sensor  
..... 188, 189, 190, 191  
Automatic Output ..... 146  
Automatic Storage ..... 133  
Average ..... 104  
average ..... 84, 86

## B

---

Backlight ..... 93  
Backup data file ..... 119  
BAUD RATE ..... 92  
Beep Sound ..... 94

## C

---

Clamp-On Sensor ..... 32, 71  
Clock ..... 96  
Computer ..... 149  
Connection ..... 37  
Contrast Control ..... 20  
Copying ..... 132  
Copying a Screen ..... 148  
Copying Screen ..... 139  
CT ..... 70  
Current flow direction arrow ..... 51  
Current Input terminals ..... 20  
Current Range ..... 54, 57, 69

## D

---

D/A Output ..... 161, 163  
D/A Output Terminal ..... 21, 161  
Data Output Setting Screen ..... 72  
Deleting a File ..... 130  
Demand ..... 85, 108  
Display ..... 117, 118  
Display Average Times ..... 66  
Dynamic range overflow warning ..... 57

## E

---

External Input/Output Terminal 21, 155

## F

---

File ..... 123  
File Name ..... 80  
file screen ..... 22  
Files ..... 119  
FLOW CONTROL ..... 92  
Formatting ..... 124, 125  
Formulae ..... 184  
Functions of the External Input/Output  
Terminal ..... 156

## H

---

Harmonic ..... 86, 109  
Harmonic content ..... 110, 113  
Harmonic Graph ..... 112  
Harmonic level ..... 110, 113  
Harmonic List ..... 109  
Harmonic Phase Angles ..... 209  
Harmonic-power phase angle 110, 113  
Harmonic-voltage (current) phase angle  
110, 113  
Holding ..... 118

<b>I</b>	
ID No. ....	95
Indicators .....	24
input cord label .....	34
Inspection .....	26
Instantaneous Values .....	99
Instantaneous values .....	101
instantaneous values .....	84, 86
Integrated power .....	85, 107
Integrated Power Output Rate .....	165
Internal Memory .....	124
Interval .....	78, 135
<b>K</b>	
KEY LOCK .....	20
<b>L</b>	
Language .....	97
LCD .....	93
Loading a Setting File .....	128
<b>M</b>	
Maximum .....	104
maximum .....	84, 86
Measurement .....	73
Measurement data file .....	119
Measurement Range .....	56
measurement screen .....	22
Measurement Setting Screen .....	60
measurement start .....	73
measurement stop .....	75
Minimum Values .....	104
minimum values .....	84, 86
multiple circuits .....	40
Multiple-Circuit .....	47
<b>N</b>	
Neutral Current .....	46
number of output data .....	83
<b>O</b>	
Order .....	88, 91
Output Waveform .....	168
Over range .....	57
<b>P</b>	
PC Card .....	21, 121, 125
PC card .....	120
PLL .....	63
Power .....	101
Power Cord .....	28
Power Outage .....	173
Power Range Configuration ..	188, 189, 190, .....
POWER switch .....	20, 36
Printer .....	141
PT .....	68
<b>R</b>	
Reactive-power-meter method .....	65
Response .....	166
RS-232C .....	21, 81, 92, 144, 150
<b>S</b>	
Save/Print Items Setting Screen .....	83
Saving .....	119
Saving a Setting File .....	126
Saving Data .....	79
Saving Measurement Data Manually ...	137
Screen copy file .....	119
Screen is to be Copied .....	82
Sensor .....	51
Setting file .....	119
Setting Screen .....	59
setting screen .....	22
start time .....	74
Status .....	120
Stop Time .....	76
Storable Time .....	83, 135



System Reset .....	199
System Setting Screen .....	89

## T

---

TERMINATOR .....	92
THD .....	90
THD-F .....	90
THD-R .....	90
TIMER .....	75
Total Harmonic Distortion .....	90

## V

---

Version .....	98
Voltage Cords .....	29, 50
Voltage cords .....	31
Voltage Input terminals .....	20
Voltage Range .....	53, 56, 67
VT .....	68

## W

---

Waveform .....	102
Waveform data file .....	119
WIRING CHECK .....	52
Wiring Diagram .....	38
Wiring Method .....	61

## Z

---

Zoom Screen .....	117
-------------------	-----



# Warranty Certificate

# HIOKI

Model	Serial number	Warranty period Three (3) years from date of purchase ( ___ / ___ )
-------	---------------	--

Customer name: \_\_\_\_\_

Customer address: \_\_\_\_\_

## Important

- Please retain this warranty certificate. Duplicates cannot be reissued.
- Complete the certificate with the model number, serial number, and date of purchase, along with your name and address. The personal information you provide on this form will only be used to provide repair service and information about Hioki products and services.

This document certifies that the product has been inspected and verified to conform to Hioki's standards.

Please contact the place of purchase in the event of a malfunction and provide this document, in which case Hioki will repair or replace the product subject to the warranty terms described below.

## Warranty terms

1. The product is guaranteed to operate properly during the warranty period (three [3] years from the date of purchase).  
If the date of purchase is unknown, the warranty period is defined as three (3) years from the date (month and year) of manufacture (as indicated by the first four digits of the serial number in YYMM format).
2. If the product came with an AC adapter, the adapter is warranted for one (1) year from the date of purchase.
3. The accuracy of measured values and other data generated by the product is guaranteed as described in the product specifications.
4. In the event that the product or AC adapter malfunctions during its respective warranty period due to a defect of workmanship or materials, Hioki will repair or replace the product or AC adapter free of charge.
5. The following malfunctions and issues are not covered by the warranty and as such are not subject to free repair or replacement:
  - 1. Malfunctions or damage of consumables, parts with a defined service life, etc.
  - 2. Malfunctions or damage of connectors, cables, etc.
  - 3. Malfunctions or damage caused by shipment, dropping, relocation, etc., after purchase of the product
  - 4. Malfunctions or damage caused by inappropriate handling that violates information found in the instruction manual or on precautionary labeling on the product itself
  - 5. Malfunctions or damage caused by a failure to perform maintenance or inspections as required by law or recommended in the instruction manual
  - 6. Malfunctions or damage caused by fire, storms or flooding, earthquakes, lightning, power anomalies (involving voltage, frequency, etc.), war or unrest, contamination with radiation, or other acts of God
  - 7. Damage that is limited to the product's appearance (cosmetic blemishes, deformation of enclosure shape, fading of color, etc.)
  - 8. Other malfunctions or damage for which Hioki is not responsible
6. The warranty will be considered invalidated in the following circumstances, in which case Hioki will be unable to perform service such as repair or calibration:
  - 1. If the product has been repaired or modified by a company, entity, or individual other than Hioki
  - 2. If the product has been embedded in another piece of equipment for use in a special application (aerospace, nuclear power, medical use, vehicle control, etc.) without Hioki's having received prior notice
7. If you experience a loss caused by use of the product and Hioki determines that it is responsible for the underlying issue, Hioki will provide compensation in an amount not to exceed the purchase price, with the following exceptions:
  - 1. Secondary damage arising from damage to a measured device or component that was caused by use of the product
  - 2. Damage arising from measurement results provided by the product
  - 3. Damage to a device other than the product that was sustained when connecting the device to the product (including via network connections)
8. Hioki reserves the right to decline to perform repair, calibration, or other service for products for which a certain amount of time has passed since their manufacture, products whose parts have been discontinued, and products that cannot be repaired due to unforeseen circumstances.

**HIOKI E.E. CORPORATION**

<http://www.hioki.com>

18-07 EN-3





# HIOKI

<http://www.hioki.com>



**Our regional  
contact  
information**

## **HEADQUARTERS**

81 Koizumi  
Ueda, Nagano 386-1192 Japan

## **HIOKI EUROPE GmbH**

Rudolf-Diesel-Strasse 5  
65760 Eschborn, Germany  
[hioki@hioki.eu](mailto:hioki@hioki.eu)

1808EN

---

Edited and published by HIOKI E.E. CORPORATION

Printed in Japan

- CE declarations of conformity can be downloaded from our website.
- Contents subject to change without notice.
- This document contains copyrighted content.
- It is prohibited to copy, reproduce, or modify the content of this document without permission.
- Company names, product names, etc. mentioned in this document are trademarks or registered trademarks of their respective companies.